



WALL AND CORNER PROTECTION AND ARCHITECTURAL SYSTEMS

www.arfen.com



entrance
mat systems

aluminium &
PVC skirtings

decoration
profiles

wall & corner
protection
systems



for information



Efectis



ARFEN®



Since the day it was founded, ARFEN has been producing solutions in high quality standards to meet construction and industrial sectors demand, and has achieved significant success with its business partners not only in domestic markets but also in international markets. To be able to reach this success, our motto strictly have been " Continues in quality and customer focused approach". Arfen continues its activities in 25.000 m2 closed area in İstanbul Hadımköy Industrial area, Çorlu Organized Industrial area and Gebze Organized Industrial area. It has become one of the most significant and greatest manufacturer in plastic, alu minum and rubber industry with a management approach that has adopted the principle of specialization in manufacturing. While Arfen applies modern production systems, it also provides sensitivity to work safety, human health and environment. Arfen fulfills the need of construction industry with its dilatation profiles, Arfen Bridge expansion profiles and bearings, Arfen decoration profiles, Viny wall and corner protection systems, Aluminum matting systems and Hydroflex & chamfer bands. Moreover, having available high machinery and equipment capacity, Arfen meets the specific product requirements of different sectors. As a result of working in numerous projects without any problems, Arfen has gained a Global market network coverage in more than 50 countries in the construction industry. Arfen's perfection and excellence in production quality is provided by its hard working and honest employees from lowest levels to top managers. After 20 years of working with an understanding of business and ethics, we would like to thank our employees, our customers and suppliers for their contributions.



Arfen Construction Company / İSTANBUL



Arfen Aluminium Company / TEKİRDAĞ



Arfen Bridge and Building Technology Company / İZMİT



ADVANTAGES

- ✓ Our products certified by ce and under quality classifications of ISO 9001:2008
- ✓ Our products have VOC test report which is not included harmful gas to human nature
- ✓ Our materials do not contain heavy metals, according to that the materials are not harmful and due to that they have ROHS certified.
- ✓ Our materials are antibacterial. we have test report by TÜBITAK.
- ✓ We have impact test report and fire classification of B1.
- ✓ Impact strength has reported by Yıldız Technical University with high values.
- ✓ Environmental effects considered by ÇED certification.
- ✓ Our end caps made by "Polyamide 6" instead of "ABS" and it has 4-5 times more than impact resistance and not fragile as "ABS".
- ✓ Impact absorber TPE inserts have resistance to all weather conditions and have TSE document.
- ✓ All raw materials (plastic, aluminium) used for our manufacturing process are all recyclable.





COLOUR OPTIONS

Note: Colors are printing colors.
For color selection, please ask for a color chart.



20- WHITE



21- OFF WHITE



23-IVORY CREAM



24- WHEAT



25- SAND BEIGE



26- CAPPUCINO



28- LIGHT BROWN



29- BEIGE



30- CINNAMON



32- MOCHA



39- PEARL GREY



40- POLISHED GREY

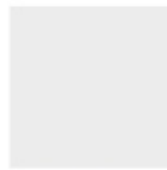

41- LIGHT GREY



42- DARK GREY



43- ANTHRACITE GREY



48- MIMOSA



49- YELLOW



50- HARDAL



51- MANDARIN



52- CORAL



53- ROSE BUFF



54- BRONZE



58- RED



59- BORDEAUX



70- LIGHT GREEN



71- LIGHT TURQUOISE



72- DARK TURQUOISE



74- PISTACHIO GREEN



75- DARK GREEN



80- ICE BLUE



81- LIGHT BLUE



82- LILAC



83- BLUE



84- SKY BLUE



85- DARK BLUE

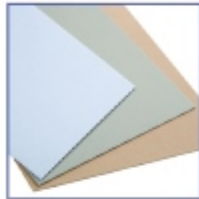

VINYL PLATE SYSTEMS

They are antibacterial wall protection sheets and tapes that protect the impact area in operating rooms, cold rooms, narrow corridors and service corridors, reducing paint and maintenance costs.

PAGE
05-10



HANDRAIL AND WALL PROTECTION

They are wall protection with their handrail form that are used in structures such as hospitals, nursing homes and clinics to protect people against accidents and falls.

PAGE
11-16



HANDRAIL SYSTEMS

It is used for holding in school, hotel, hospital corridors and common areas. At the same time, it is used for holding purposes in disabled rooms and wet areas.

PAGE
17-24



CRASH RAIL SYSTEMS

They are vinyl protective systems on aluminum used to reduce maintenance and repair costs, and to protect people and places against impacts with their shock absorbing structure.

PAGE
25-34



CORNER PROTECTION SYSTEMS

They are vinyl over aluminum or adhesive vinyl corner protection systems used to protect the corners of walls and columns and those that hit areas in all kinds of structures and to absorb impacts.

PAGE
35-38



RUBBER & TPE WALL AND CORNER PROTECTION SYSTEMS

They are rubber or TPE based wall and corner protection systems that do not absorb impacts in all kinds of parking structures and service corridors, loading and unloading areas.

PAGE
40-46



STAINLESS STEEL PROTECTION SYSTEMS

They are wall and corner protection bands and handrail systems of various types and sizes, made of 304 or 316 quality stainless according to the nameplate.

PAGE
47-51



STANDARD ENTRANCE MAT SYSTEMS

They are indoor and outdoor matting systems with 22 mm height carpet, rubber, brush, scraper top surface.

PAGE
53-57

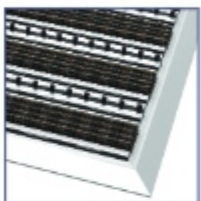

THIN SERIES ENTRANCE MAT SYSTEMS

They are also indoor and outdoor matting systems with 12 mm high carpet, rubber, brush, scraper top surface.

PAGE
58-65



ALUMINUM AND PVC SKIRTINGS

They are decorative and functional aluminum and PVC skirting details from 50 mm to 150 mm.

PAGE
66-74



STAIR NOSE PROFILES

They are stair nosing profiles in various sizes produced from aluminum, PVC and non-slip tapes.

PAGE
75-77

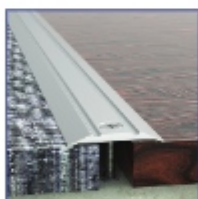

TRANSITION, LEVEL DIFFERENCE, CARPET AND PARQUET FINISH PROFILES

They are used at the points where the finishing and interlacing of various floor coverings such as parquet, ceramic, granite, marble, carpet are required.

PAGE
78-79

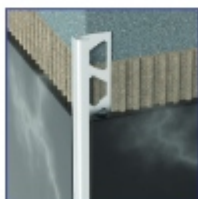

CERAMIC, MARBLE, GRANITE, CORNER AND FINISH PROFILES

Bathtub edge and border Profiles
Terrazzo finish profiles
Drywall end-start profiles

PAGE
80-82

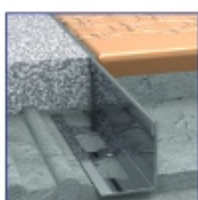
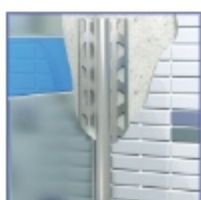

STAINLESS STEEL PROFILES

It covers the stainless models of ceramic inner and outer corner, skirting and corner protection profiles.

PAGE
83-84

Antibacterial Decorative Wall Protection Panels



LESS PAINTING



LESS MAINTENANCE



LESS COST IN 4 YEARS

Anti bacterial vinyl sheets produced according to prevent wear and tear on walls and door surfaces indoors, against scratches and bumps with 32 colour options. You can beautify your places with our presented models with decorative pictures. This increases the use in various places.

Beacuse of the antibacterial future; specially used in health and education sectors, as breif; all hygienic and sterile environment that can be applied very easy by adhesive wall coverings according to Bs2d0 fire classification (EN13501) selected for lot of projects.

Produced as 0,8 mm - 3 mm thickness with special pattern and foil covered vinyl plates; has end caps such as upper cover part, middle connection part, internal and external corner parts.In this way, the expansion that may occur due to heat change It provides ease of assembly by reducing the problems in cases of shrinkage and shrinkage. Also, optionally between the platesIt is also possible to apply silicone sealant in its own color.

Thanks to special cuts and picture prints, Although the usage areas are very wide, it is used in schools, hospitals, in hotels, shopping malls, kindergartens, airport terminal buildings, in all sterile and hygienic corridors,It is used intensively in the service traffic corridors.

Vinyl wall panels are cleanable and aesthetic properties, as well as reducing maintenance and repair costs. It has a contemporary texture and structure that is more preferred than other alternative wall protection products.



EDUCATIONAL AND DECORATIVE WALL PLATES

Space Explorer

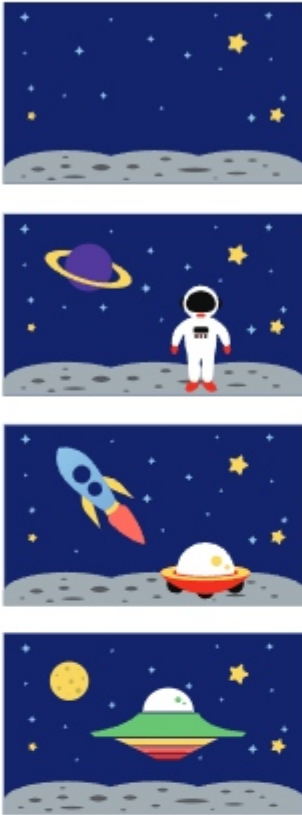

Green Garden



Blue Sky



Let's Learn the Traffic Rules



Go to Bed Early
Wake Up Early



Throw the Garbage
in the Trash Bin



I Wash
My Hands Often



I Always Get On
Well With My Friends



I Always Say Hi



WG1004

ARFEN VINYL PLATES

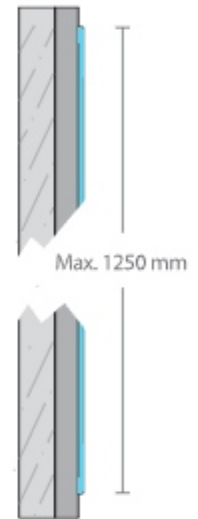
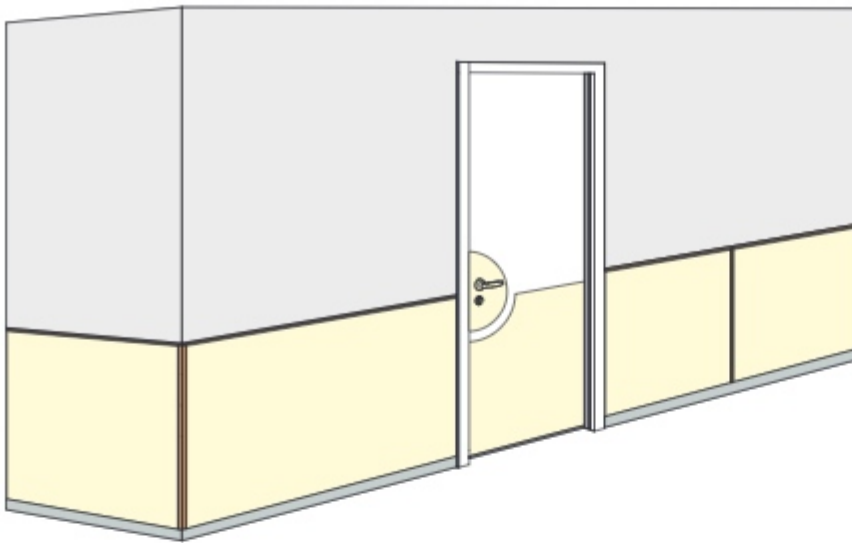

VINYL PLATE DIMENSIONS

Width	Height	t1 (mm)	t2 (mm)	t3 (mm)
1000	2000	1	1,5	2
1000	3000	1	1,5	2
1200	2400	1	1,5	2
1200	3000	1	1,5	2
1250	2500	1	1,5	2
1250	3000	1	1,5	2

Unless otherwise stated, our standard production is 1000x3000x1,5 mm

According to the calculations, in case of repairing the paint every 2 years vinyl plate system pays for itself in 4 years

WG 1004 vinyl sheet is produced in 1 mm, 1.5 mm and 2 mm thicknesses and in 1000 mm, 1200 mm, 1250 mm widths and various lengths. They are decorative sheets that are adhered to the walls with special adhesives and protect your walls from scratches. Easily cleanable and washable thanks to its structure, it meets the needs of a wide area from hospitals to production areas. As it is produced in different colors, the vinyl plates are suitable with the other construction materials. 1.5 mm is produced as standard. Others can be produced according to order quantity.



OPTIONAL ACCESSORIES



UPPER COVER WG1004-1



CONNECTION PART WG1004-2



INTERNAL END CAP WG1004-3



EXTERNAL END CAP WG 1004-4

VINYL PLATES ASSEMBLY PARTS

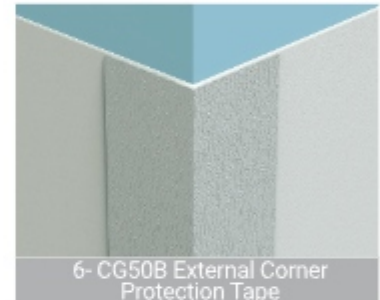

WG154-204-304 ARFEN VINYL PLATES

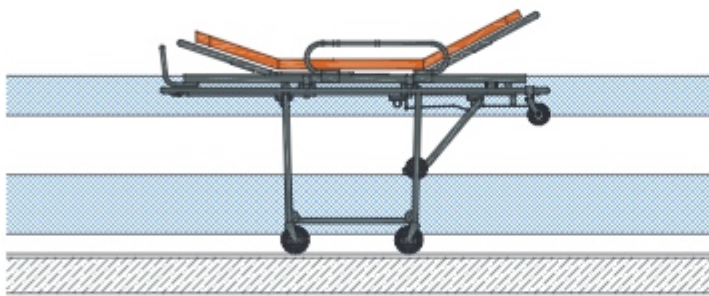
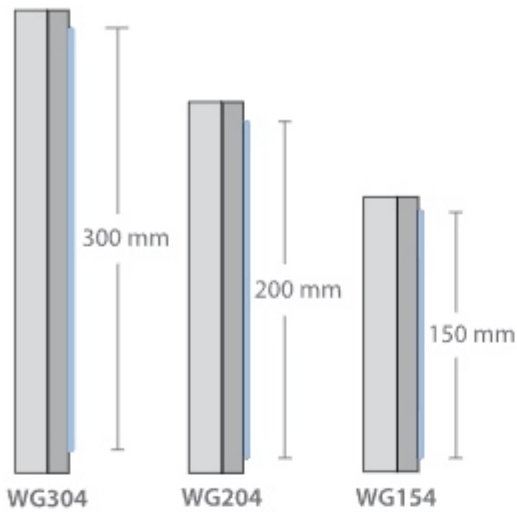

WG154 - 204 - 304 vinyl plates are 2 mm thick and 150 mm, 200 mm, 300 mm width. These decorative sheets protect your walls from scratches by sticking to walls and doors with special adhesives. It is decorative with its scratch-proof top patterned structure. Since it is produced in 32 different colors, it is applied in harmony with other building materials. Plate lengths are produced in 4 meters.



ROLLER BRUSH

VINYL BOND PLATE ADHESIVE



DG SERIES

VINYL DOOR KICK PLATE

The diagram shows ten different vinyl door kick plate designs, each labeled with a code:

- DG01: Brown base with a semi-circular top edge.
- DG03: Green base with a wavy top edge.
- DG07: White base with a curved top edge.
- DG10: White base with a green semi-circular top edge.
- DG11: Orange base with a trapezoidal top edge.
- DG12: Purple base with the number '23' in white.
- DG13: Light blue base with a vertical bar on the right side.
- DG14: White base with two horizontal orange bars.
- DG15: Blue silhouette of a male figure.
- DG16: Pink silhouette of a female figure.

To the right of the grid is a 3D perspective view of a yellow door with a teal kick plate. A callout shows a yellow rectangular piece of the kick plate being applied to the bottom of the door.

ARFEN Vinyl Door Kicking Plate has a special design in order to prevent doors from being damaged and also creating a decorative appearance. As the colors used are compatible with the wall and corner protection systems, an integrity is achieved. It is hygienic with its antibacterial structure and provides full protection. Production can be made in standard sizes and models, as well as alternatives can be developed on a project basis. Door protection plates, which are widely used, are especially suitable for hospitals, schools and commercial areas. Profile lengths are 4 meters and are produced in 32 different colors.



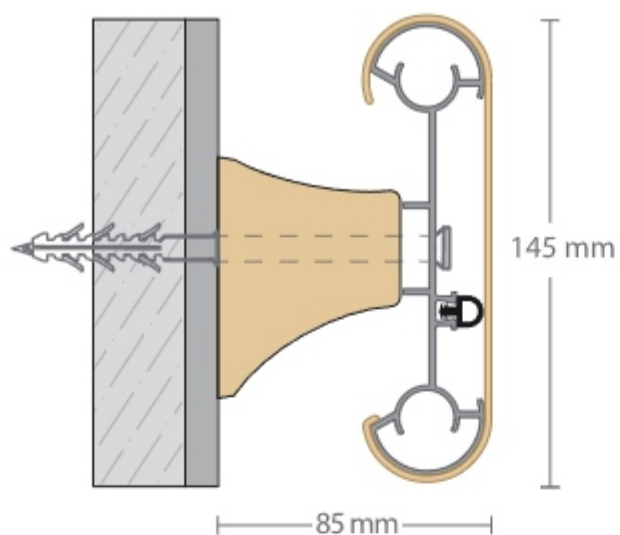

WG145

HANDRAIL WALL PROTECTION

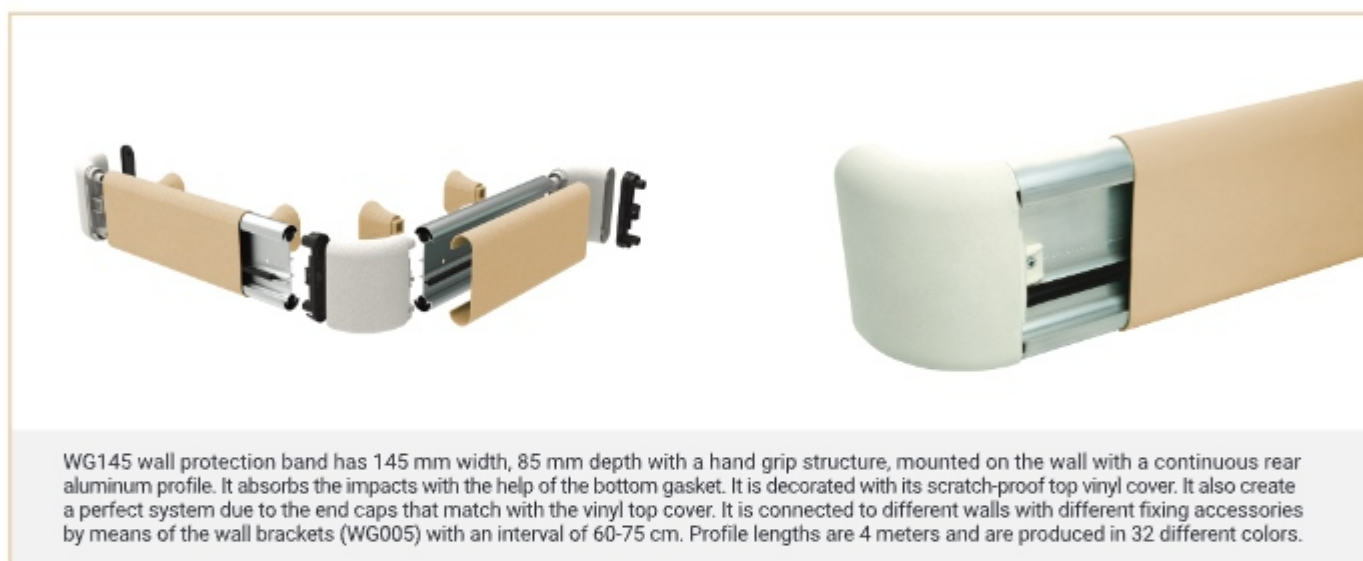

WG 005
BRACKET



WG006
LEFT AND RIGHT END



WG007-1
INTERNAL CORNER



WG007-2
EXTERNAL CORNER

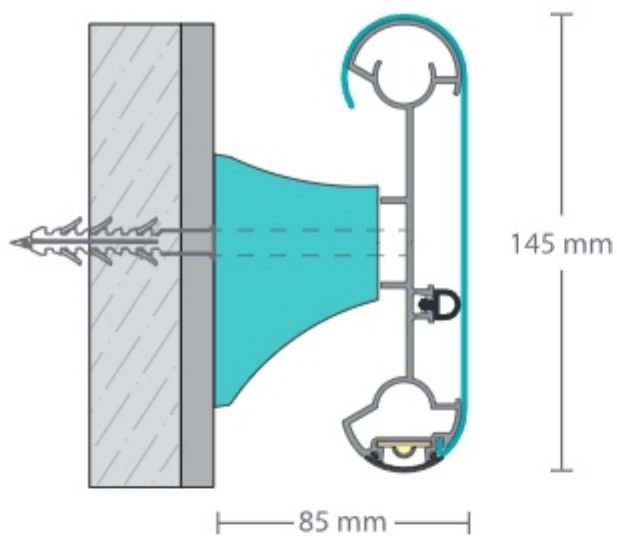

WG145-1

WALL PROTECTION HANDRAIL WITH LED

HANDRAIL WALL
PROTECTION
SYSTEMS



WG145-1 is LED illuminated handrail and wall protection with a width of 145 mm and a depth of 85 mm, mounted on the wall with a continuous aluminum profile. It absorbs the impacts due to the bottom rubber wicks. It is decorated with its scratch-proof top vinyl cover. It also create a perfect system with the end caps that look the same as the vinyl top cover. It is connected to different walls with different fixing accessories by means of the wall bracket (WG005) with an interval of 60-75 cm. Profile lengths are 4 meters and are produced in 32 different colors.



WG 005
BRACKET



WG006
LEFT AND RIGHT END



WG007-1
INTERNAL CORNER



WG007-2
EXTERNAL CORNER

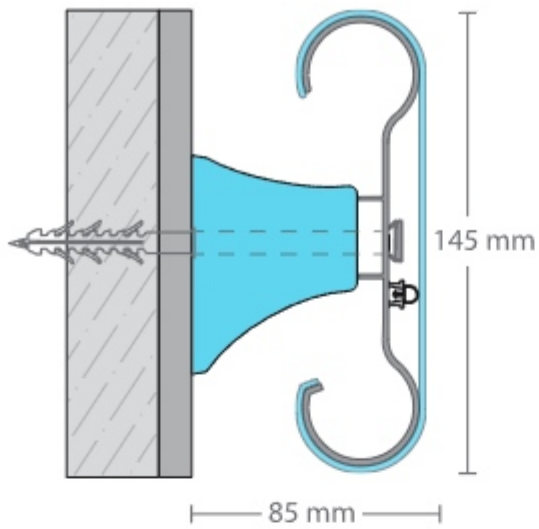

WG146

HANDRAIL WALL PROTECTION SYSTEM



WG146 is a handrail and wall protection with a width of 145 mm and a depth of 85 mm, mounted on the wall with a continuous aluminum profile. It absorbs the impacts due to the bottom rubber wicks. It is decorated with its scratch-proof top vinyl cover. It creates a perfect system with the end caps that look the same as the vinyl top cover. It is also connected to different walls with different fixing accessories by means of the wall bracket (WG005) with an interval of 60-75 cm. Profile lengths are 4 meters and are produced in 32 different colors.



WG 005
BRACKET



WG006
LEFT AND RIGHT END



WG007-1
INTERNAL CORNER



WG007-2
EXTERNAL CORNER

DC140

HANDRAIL WALL PROTECTION

HANDRAIL WALL
PROTECTION
SYSTEMS

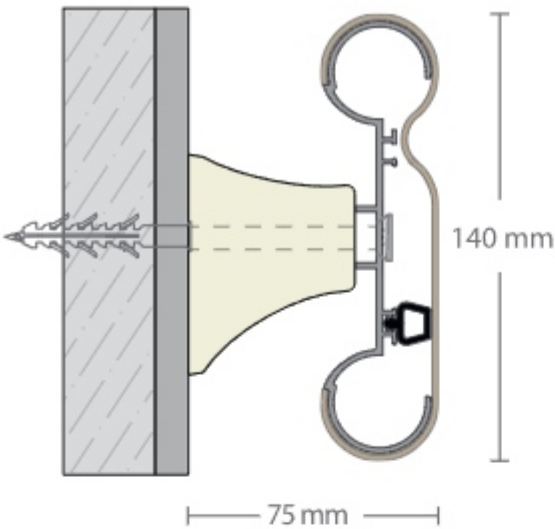

DC140 is a handrail and wall protection with a width of 140 mm and a depth of 75 mm, mounted on the wall with a continuous aluminum profile. It absorbs the impacts due to the bottom rubber wicks. It is decorated with its scratch-proof top vinyl cover. It creates a perfect system with the end caps that look the same as the vinyl top cover. It is also connected to different walls with different fixing accessories by means of the wall bracket (DC005) with an interval of 60-75 cm. Profile lengths are 4 meters and are produced in 32 different colors.



DC005 BRACKET



DC006-1 LEFT END



DC006-2 RIGHT END



DC007-1
INTERNAL CORNER



DC007-2
EXTERNAL CORNER

WG152

HANDRAIL WALL PROTECTION

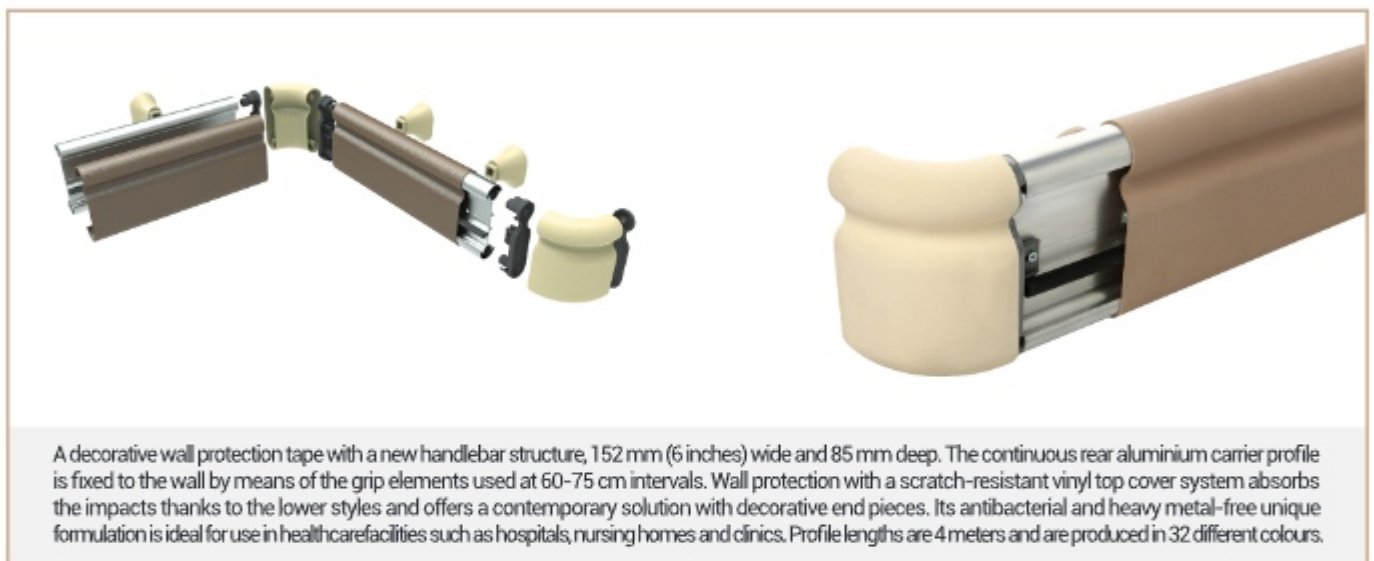
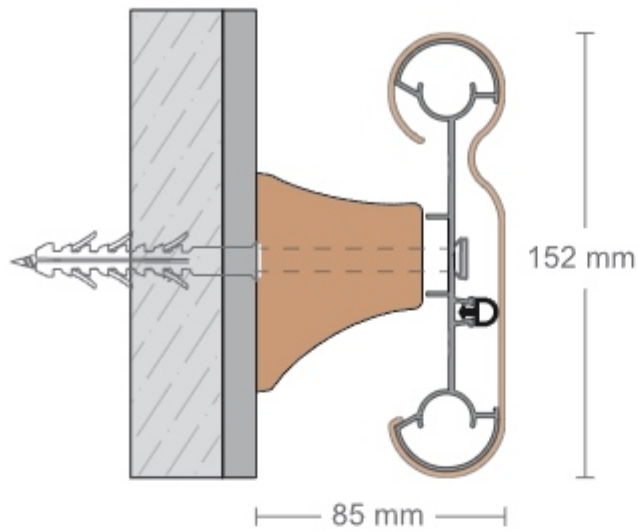

A decorative wall protection tape with a new handlebar structure, 152 mm (6 inches) wide and 85 mm deep. The continuous rear aluminium carrier profile is fixed to the wall by means of the grip elements used at 60-75 cm intervals. Wall protection with a scratch-resistant vinyl top cover system absorbs the impacts thanks to the lower styles and offers a contemporary solution with decorative end pieces. Its antibacterial and heavy metal-free unique formulation is ideal for use in healthcare facilities such as hospitals, nursing homes and clinics. Profile lengths are 4 meters and are produced in 32 different colours.

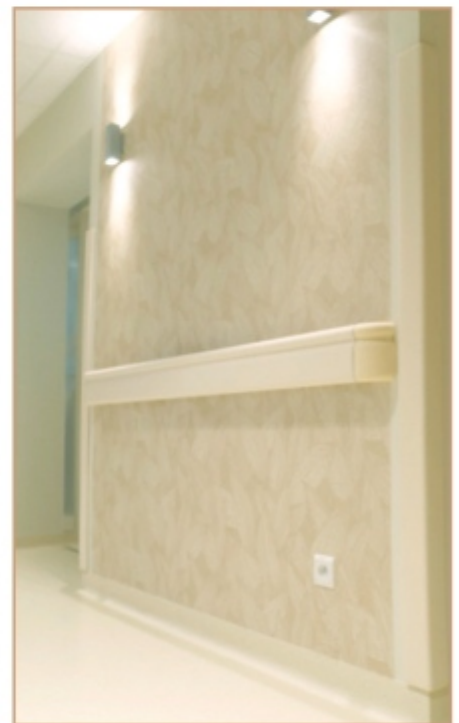

WG005 BRACKET



WG026 LEFT END



WG027 RIGHT END



WG028
OUTER CORNER



WG029
INSIDE CORNER

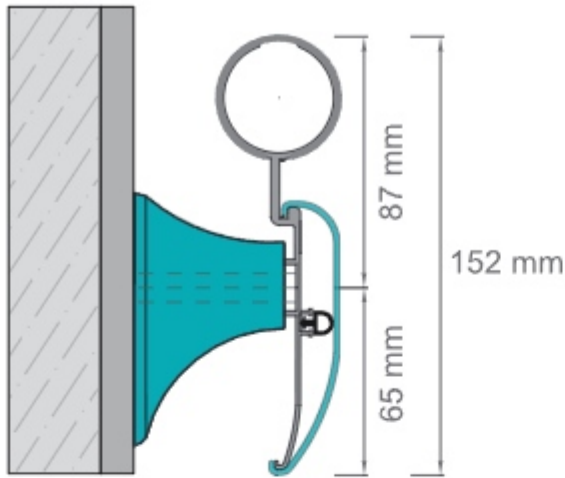

WG152-1

WALL PROTECTION WITH COMBO RAIL HANDLE

HANDRAIL WALL
PROTECTION
SYSTEMS



Arfen WG 152 combo rail is a system that completely changes the stainless strip or wood patterned strips applied to the middle part as well as allows the use of different colours of the wall protection band holding part and the lower body.

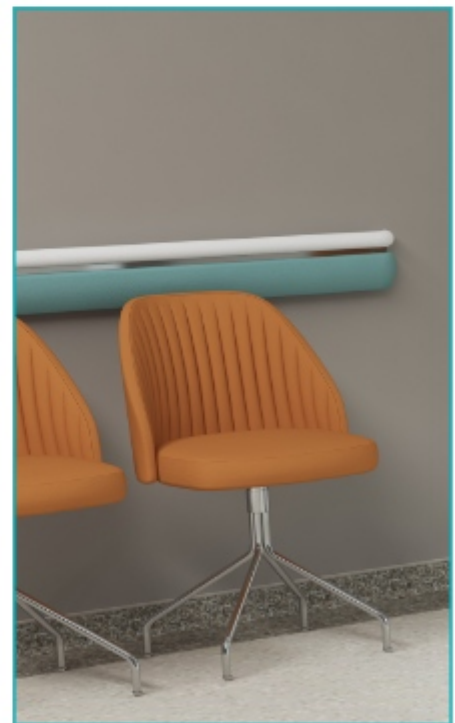

WG044 LEFT END



WG045 RIGHT END



DC 005 BRACKET

WG50

HANDRAIL SYSTEM

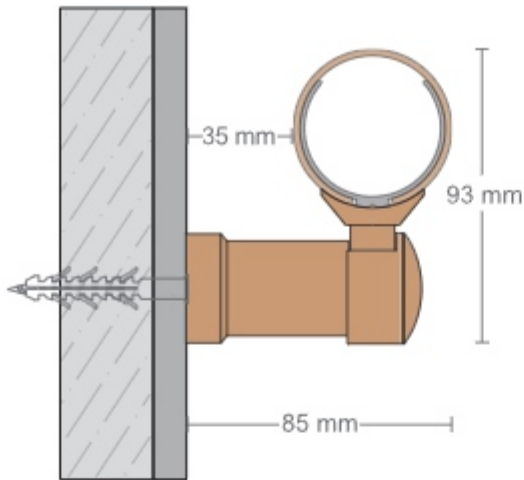

WG 50 is used sparingly in hospital corridors and common areas, stairwells. It can be used as a handrail system in buildings such as schools, hotels, shopping malls, business centres and residences due to its colour alternatives, warm decorative texture and end pieces that are not available in the handrail system. The profile lengths are 4 meters and are produced in 32 different colours.



WG010 BRACKET



WG011
HANDRAIL ELBOW



WG017
HANDRAIL RING



WG018
HANDRAIL PLUG

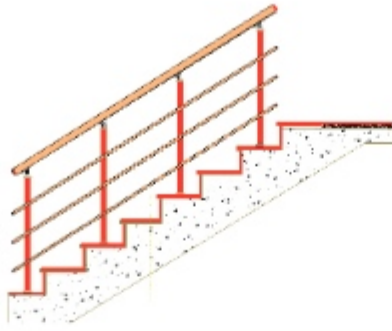

WG50

HANDRAIL SYSTEM

HANDRAIL SYSTEMS

WG010 BRACKET



WG010-1 STAINLESS BRACKET



WG011 HANDRAIL ELBOW



WG11-2 WG50 HANDRAIL INSIDE AND OUTER CORNER.



WG017 HANDRAIL RING



WG018 HANDRAIL PLUG



WGP18 18°LIK HORIZONTAL CONNECTION PROFILE



WG019 40 SHAFT HEAD SPRING.



WG021 18° OUTER PIPE SUPPORT



WG021-2 18° INNER PIPE SUPPORT



WG50 50 mm HANDRAIL PIPE



WG024 WG50 MIRROR



WG025 40 STRUT MIRROR



WG040 40°LIK STITCH PROFILE



WG041 WG40 STRUT COVER



WG022 18° PIPE PLUG



The WG50 Railing System is a patented railing system that offers colour alternatives that no other system provides for both stairwells and gallery spaces in turn structures. Due to its structural compatibility with other systems, it offers various usage options by using some accessories of stainless or aluminium. It is resistant to scratches and impacts with its internal aluminium carriers and vinyl cover. Profile lengths are 4 meters and they are produced in 32 different colours.



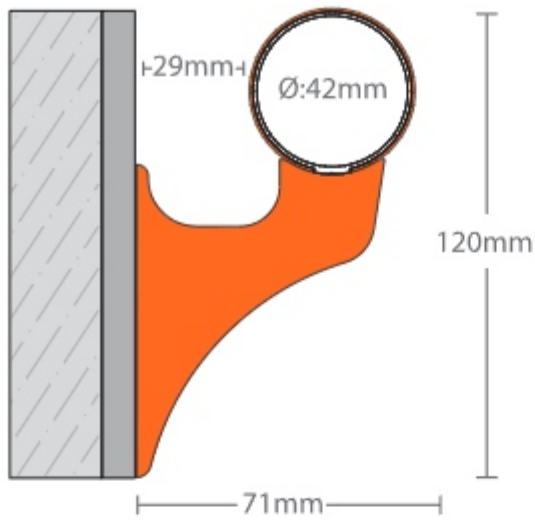

WG42-1

VINYL HANDRAIL SYSTEM



WG031 BRACKET



WG032
HANDRAIL ELBOW

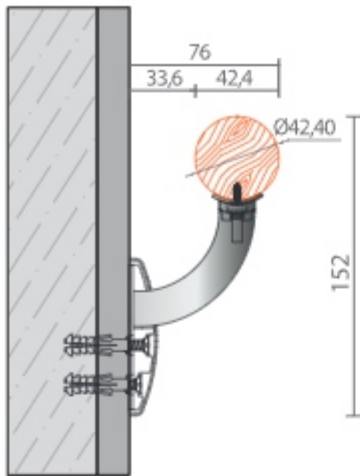

WG42-2

WOODEN HANDRAIL SYSTEM

HANDRAIL
SYSTEMS



WG 42-2 is used for holding in hospital corridors and common areas, stairwells. What makes the WG 42-2 handrail system different is that the main body is wooden and the turn fittings are stainless. Profile length: 4 meters.



WG039
STAINLESS BRACKET



WG068 SELF BRACKET
RIGHT LEFT END ELBOW

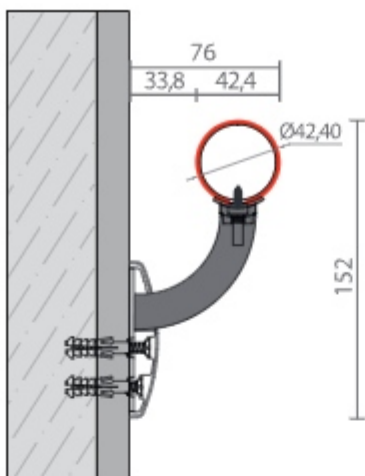

WG42-3

STAINLESS & VINYL HANDRAIL SYSTEM

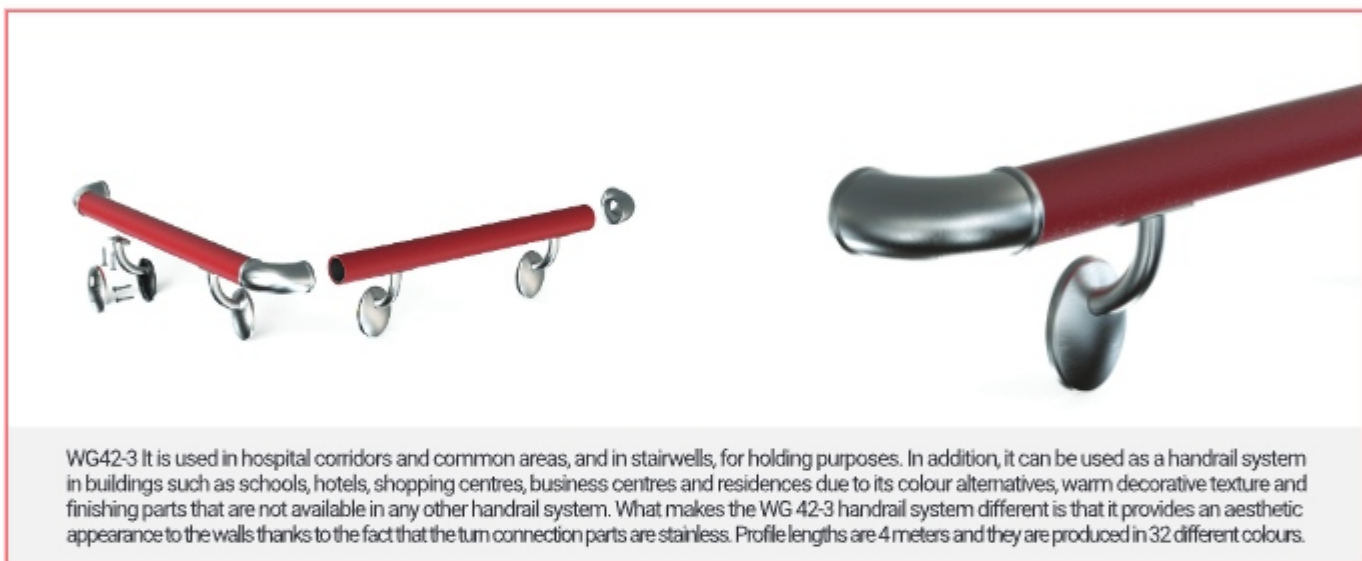

WG039
STAINLESS BRACKET



WG068 SELF BRACELET
RIGHT LEFT END ELBOW

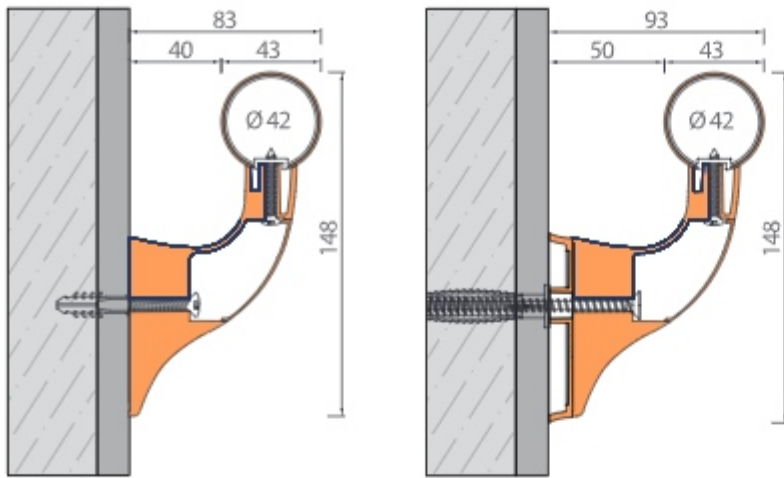

WG42-4

VINYL HANDRAIL SYSTEM

HANDRAIL SYSTEMS

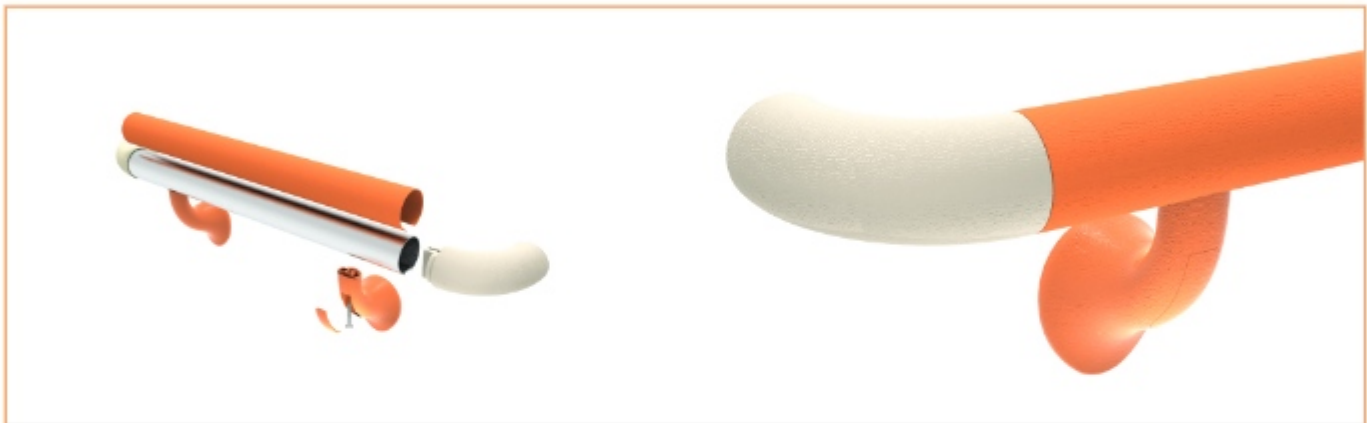

WG42-4 is used in hospital corridors and common areas, and in stairwells for holding purposes. It is a handrail system fixed 40mm away from the wall according to international standards. It is easy to assemble and it has a decorative and aesthetic look due to its plastic bracket. The profile lengths are 4 meters and they are produced in 32 different colours. It can be applied at a distance of 50 mm from the wall using the WG065 and WG066 apparatus.



WG062
HANDRAIL BRACKET



WG063
HANDRAIL ELBOW



WG065
HANDRAIL RAISING
APPARATUS



WG066
ELBOW RAISING
APPARATUS

WG42-5

HANDRAIL SYSTEM

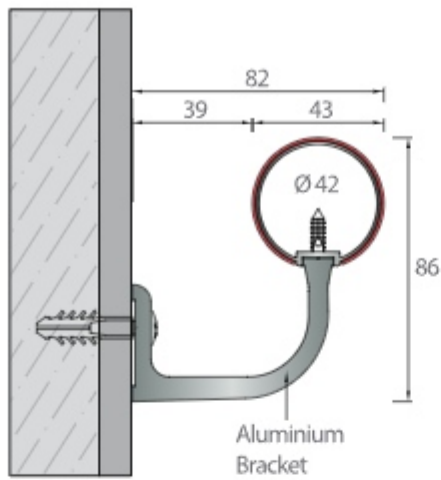

www.arfen.com



HANDRAIL
SYSTEMS



www.wallguardsystems.com

www.duvarkoruma.com

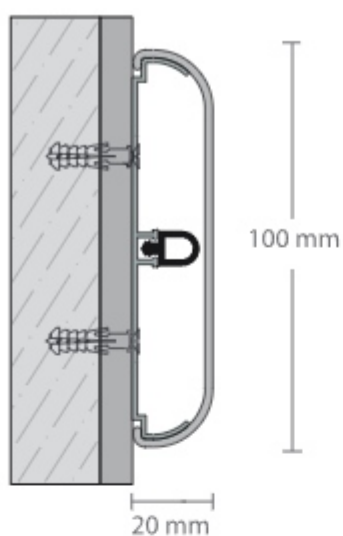

WG100

WALL PROTECTION CRASH RAIL

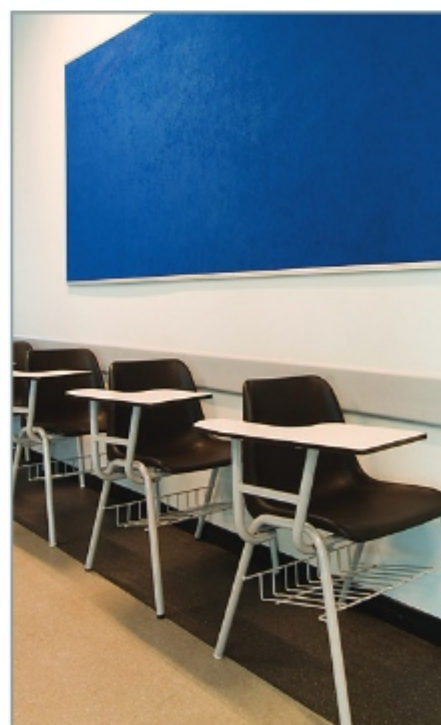
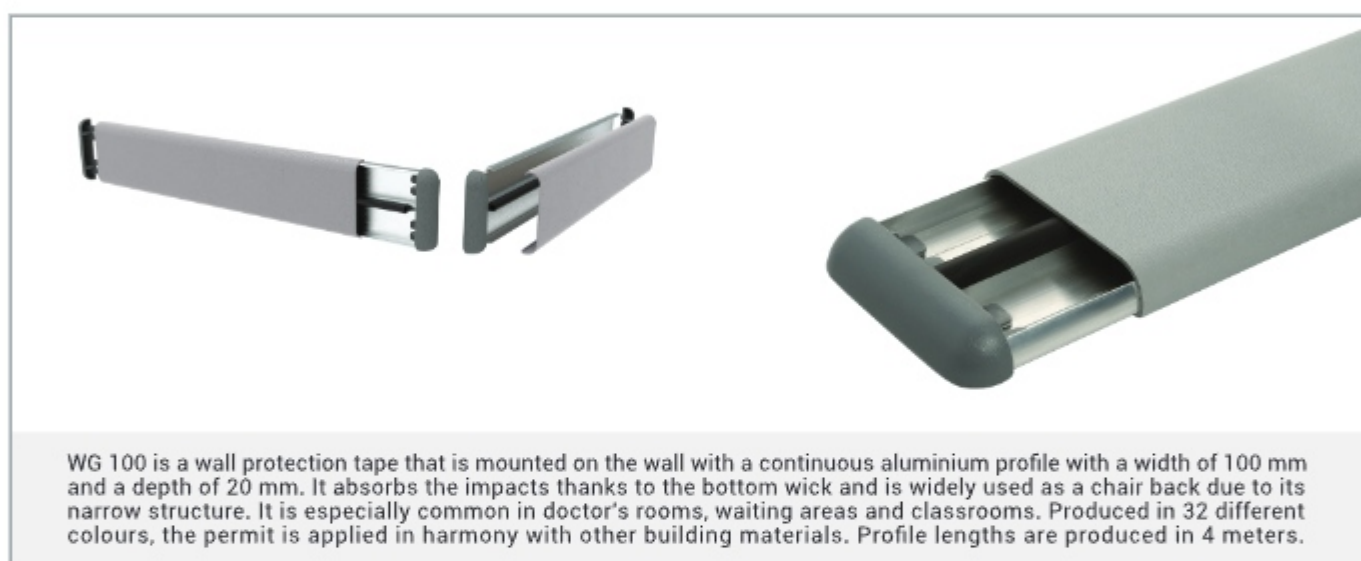

WG020
RIGHT AND LEFT END

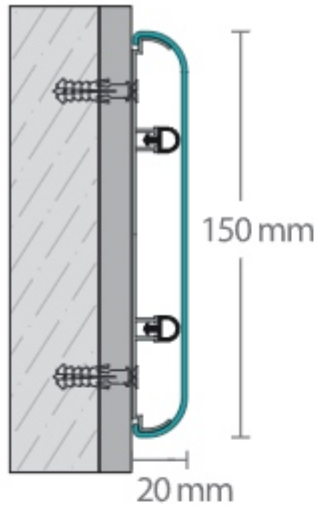

WG150

WALL PROTECTION CRASH RAIL



WG013
RIGHT AND LEFT END

WG014
OUTER CORNER



WALL
PROTECTION
SYSTEMS

WG 150 is a wall protection tape that is mounted on the wall with a continuous aluminium profile with a width of 100 mm and a depth of 20 mm. It absorbs the impacts thanks to the bottom wick. They are used to protect the walls against impacts in areas where the use of wall protection tapes with hand grips is not appropriate, especially in corridors narrower than 2 meters. Profile lengths are produced in 4 meters.

WG150-1

WALL PROTECTION

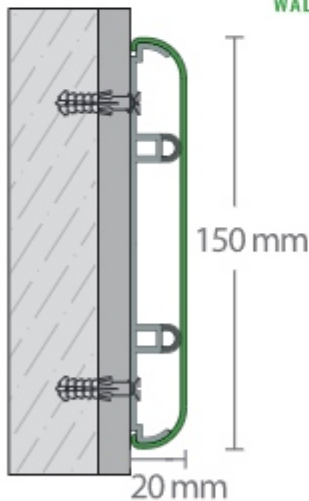



WG150-2

DOOR KICK PLATE

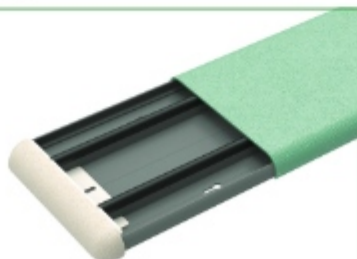

WG013-1
RIGHT AND LEFT END



Retainer is made of totally recycled PVC. That's why it is more environmentalist and economic than aluminium retainer and plastic cover.

WG036
RIGHT AND LEFT END



It is a door plinth band that is mounted on the lower part of the doors with a profile on aluminium with a width of 150 mm and a depth of 10 mm. Profile lengths of 4 meters are produced.

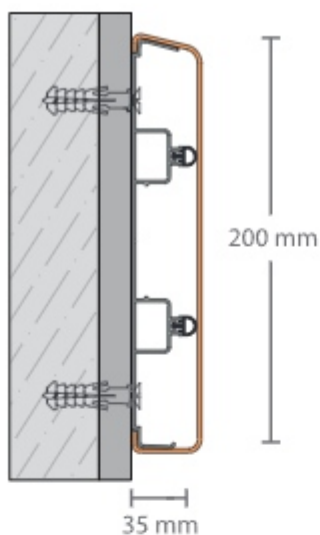

WG200

WALL PROTECTION CRASH RAIL

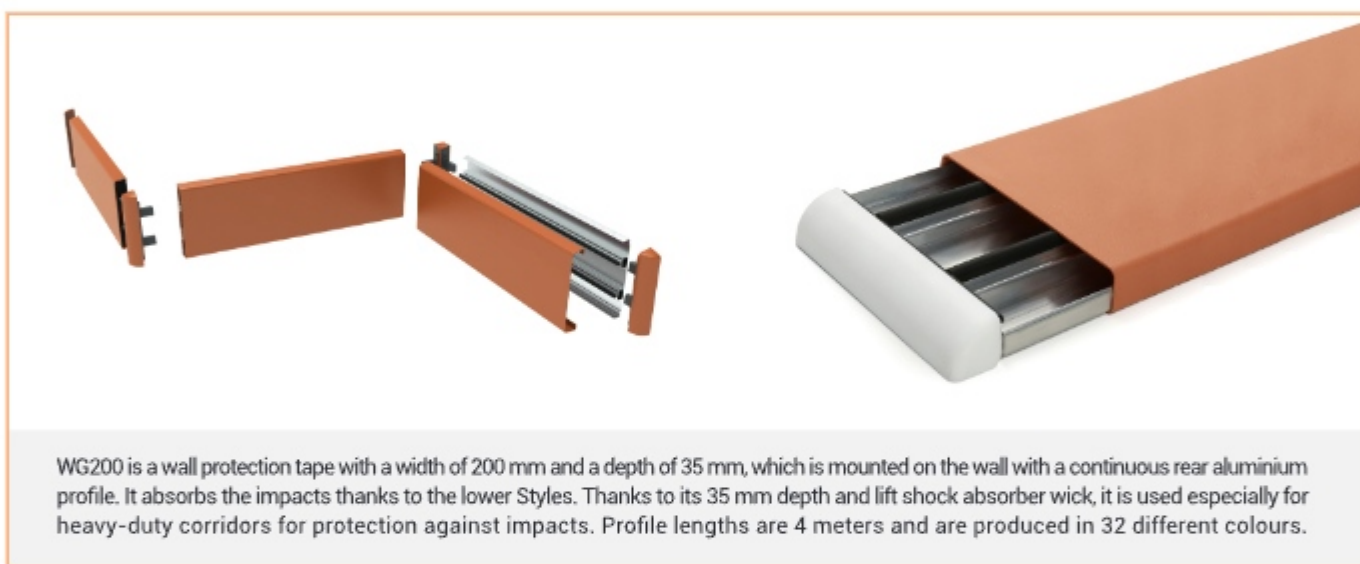

WG001
LEFT END



WG002
RIGHT END



WG003
OUTER CORNER



WG004
INNER CORNER

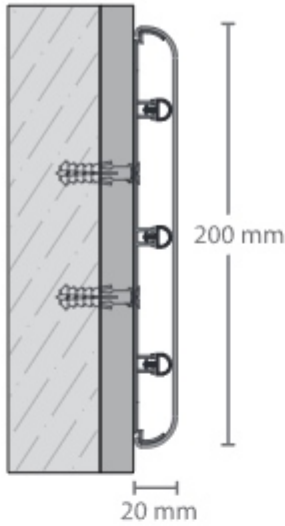

WG201

WALL PROTECTION CRASH RAIL

WALL
PROTECTION
SYSTEMS



WG 201 is a wall protection tape with a width of 200 mm and a depth of 20 mm, which is mounted to the wall with a continuous rear aluminium profile. It absorbs the impacts thanks to the lower wicks. It provides a wide protection area in corridors narrower than 2 meters thanks to its 200 mm top width. For this reason, they are highly preferred in hospital corridors that are in intensive use. Profile lengths are 4 meters and are produced in 32 different colours.



WG030
LEFT AND RIGHT END

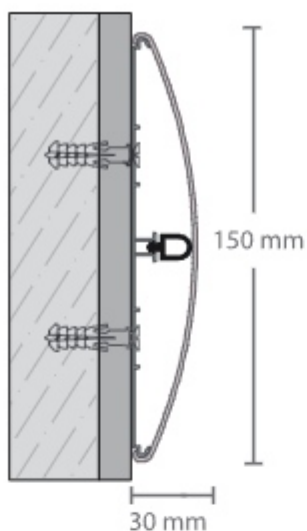

DC150

WALL PROTECTION CRASH RAIL

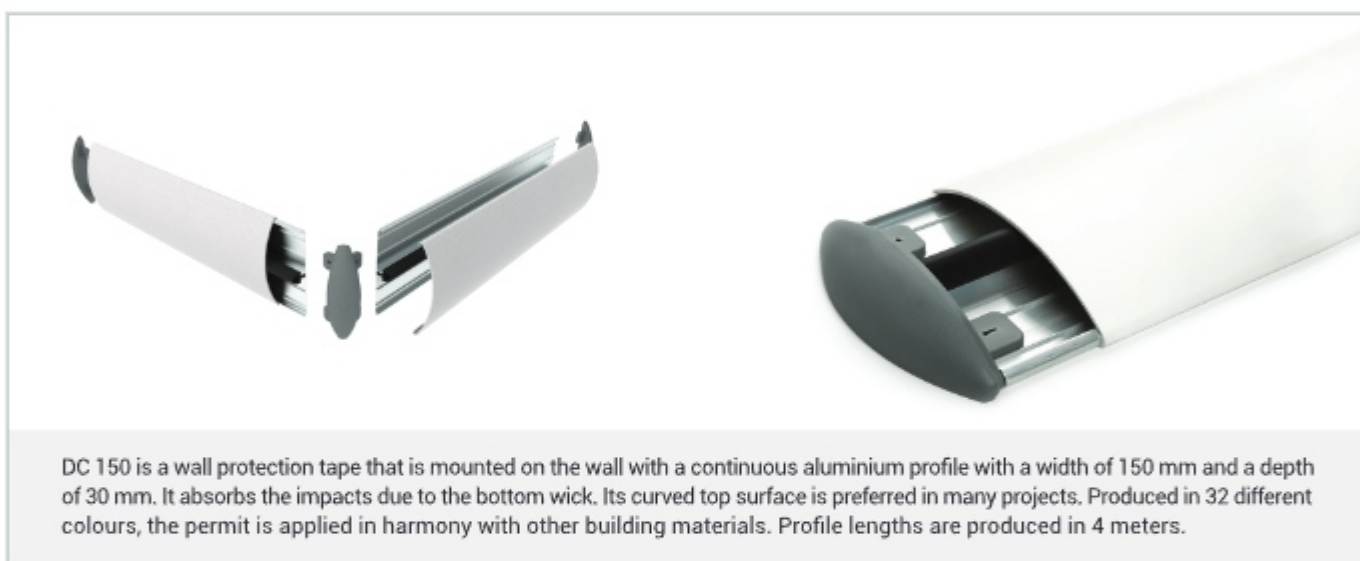

DC 150 is a wall protection tape that is mounted on the wall with a continuous aluminium profile with a width of 150 mm and a depth of 30 mm. It absorbs the impacts due to the bottom wick. Its curved top surface is preferred in many projects. Produced in 32 different colours, the permit is applied in harmony with other building materials. Profile lengths are produced in 4 meters.



DC013
RIGHT LEFT END CAP



DC014
EXTERNAL CORNER

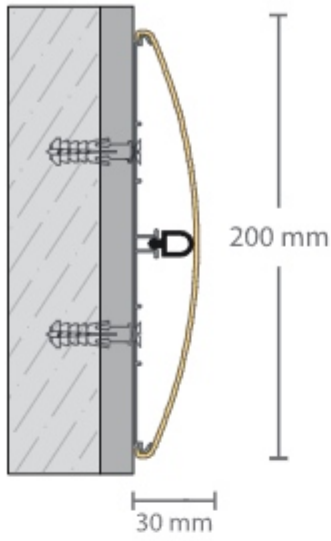

DC200

WALL PROTECTION CRASH RAIL

WALL
PROTECTION
SYSTEMS



DC 200- It is a wall protection tape that is mounted on the wall with a continuous aluminum profile with a width of 200 mm and a depth of 30 mm. It absorbs the impacts due to the bottom insert. It is decorative with its scratch-proof top vinyl cover. With the end pieces, that look the same as the vinyl top cover, a decorative finish is provided. It is manufactured in 32 different colors and provides a harmonious appearance with other building materials. Profile length is manufactured as 4 meters.

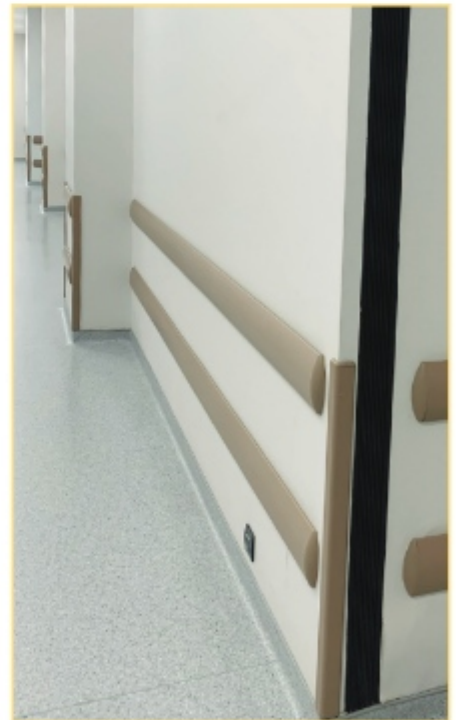

DC001
RIGHT LEFT END CAP



DC003
EXTERNAL CORNER

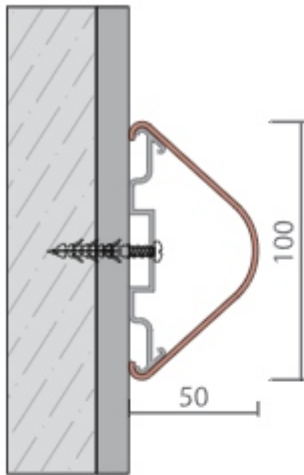

WG101

BEDHEAD PROTECTOR

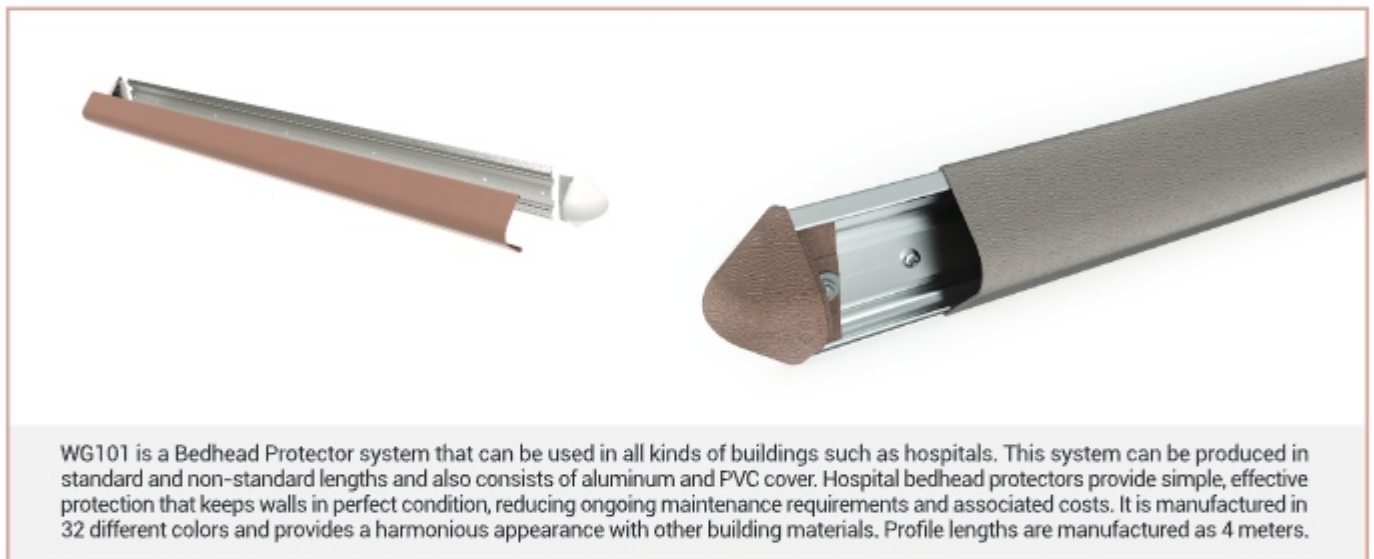

WG101 is a Bedhead Protector system that can be used in all kinds of buildings such as hospitals. This system can be produced in standard and non-standard lengths and also consists of aluminum and PVC cover. Hospital bedhead protectors provide simple, effective protection that keeps walls in perfect condition, reducing ongoing maintenance requirements and associated costs. It is manufactured in 32 different colors and provides a harmonious appearance with other building materials. Profile lengths are manufactured as 4 meters.



WG060 RIGHT AND LEFT END CAP

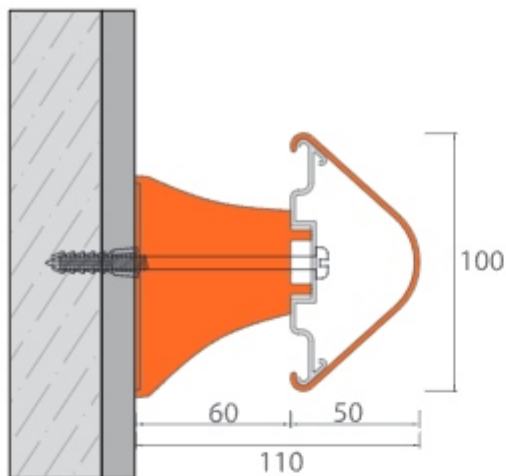

WG101

BEDHEAD PROTECTOR WITH BRACKET

WALL
PROTECTION
SYSTEMS

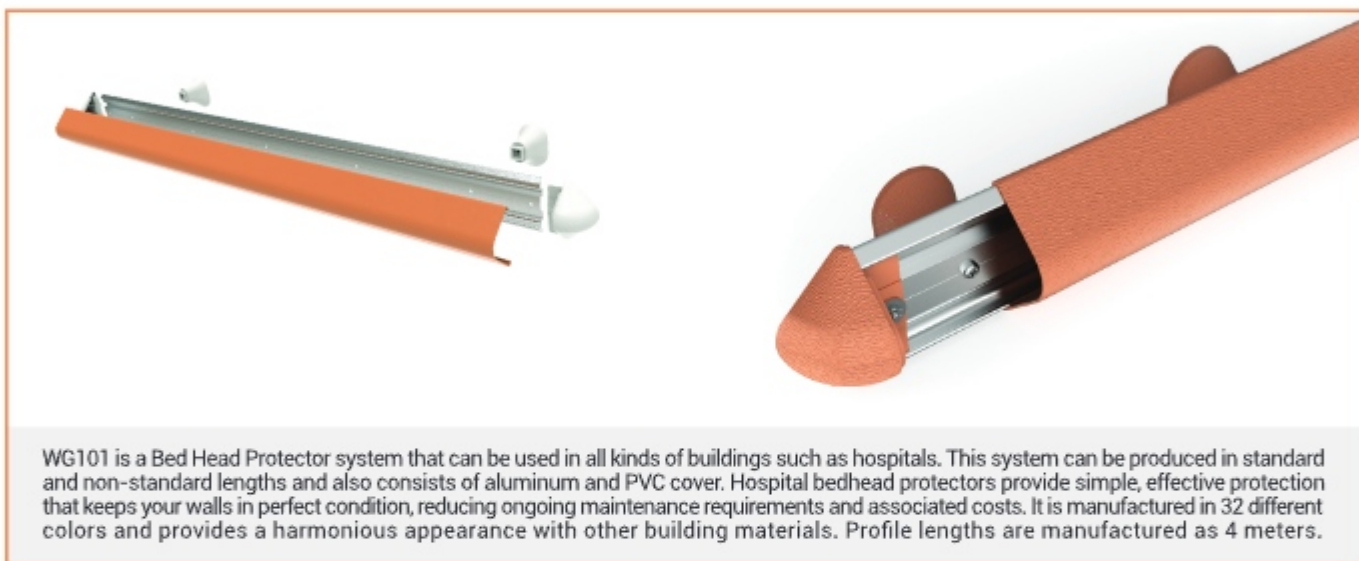

WG101 is a Bed Head Protector system that can be used in all kinds of buildings such as hospitals. This system can be produced in standard and non-standard lengths and also consists of aluminum and PVC cover. Hospital bedhead protectors provide simple, effective protection that keeps your walls in perfect condition, reducing ongoing maintenance requirements and associated costs. It is manufactured in 32 different colors and provides a harmonious appearance with other building materials. Profile lengths are manufactured as 4 meters.



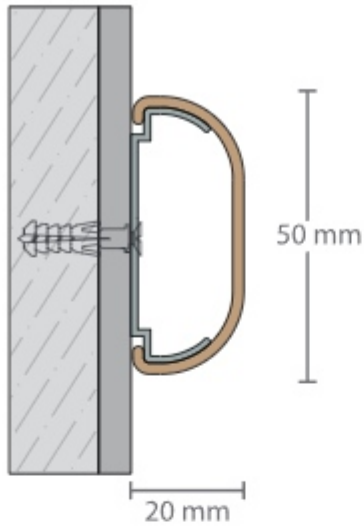

CR50

CHAIR RAIL



CR 50 is a chair's back wall protection tape that is mounted to the wall with a continuous aluminum profile with a width of 50 mm and a depth of 20 mm. It is decorative with its scratch-proof top vinyl cover. A decorative finish is provided due to the end pieces that look the same as the vinyl top cover. It is manufactured in 32 different colors and provides a harmonious appearance with other building materials. Profile lengths are manufactured as 4 meters.



WG016
RIGHT LEFT END CAP

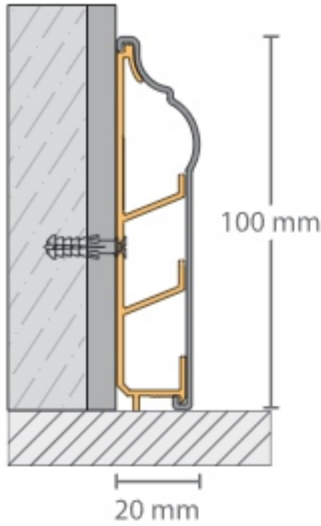

DC101

DECORATIVE PVC SKIRTING WITH CABLE DUCT



WALL PROTECTION SYSTEMS

Patterned decorative PVC skirting with cable channels. The profile has right-left end elements, external and internal corner pieces. If requested, it is priced as a piece. Profile lengths are 4 meters and are manufactured in 32 different colors.

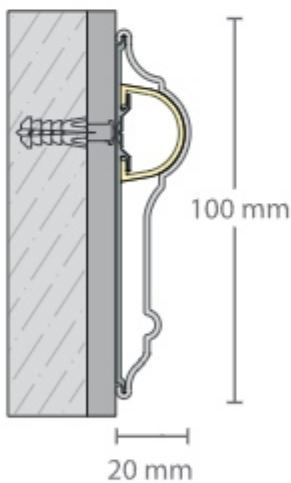

DC100

DECORATIF WALL PROTECTION TAPE

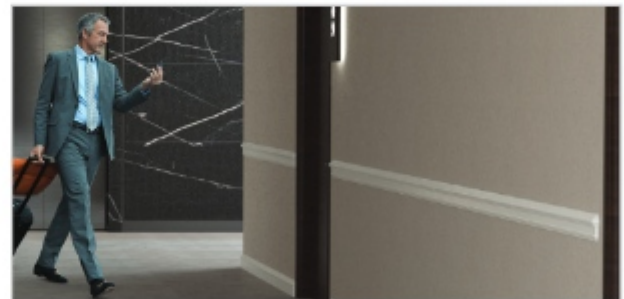

DC100 is a vinyl wall protection tape system on aluminum that is mostly used for decorative purposes in hotel and residence projects. It is decorative with its scratch-proof top vinyl cover. Profile lengths are 4 meters and manufactured in 32 different colors.

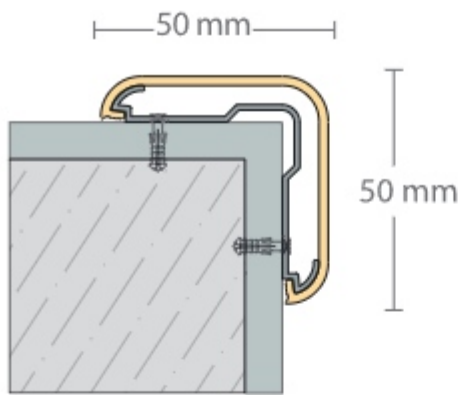

CG50

CORNER PROTECTION SYSTEM



WG012
CORNER END CAP



G50 is the corner guard which is made of non-deformable and scratch-resistant vinyl with an aluminum bottom and decorative top surface, which can be used in all kinds of structures such as hospitals, shopping malls, restaurants, hotels, dormitories, universities, dormitories, military buildings and public buildings to protect the wall corners during the use of buildings protection system. It can be produced in a specific height (L: 1 m, L: 1.50 m) as well as throughout the floor height. It is decorative with its top end cap. It is manufactured in 32 different colors.

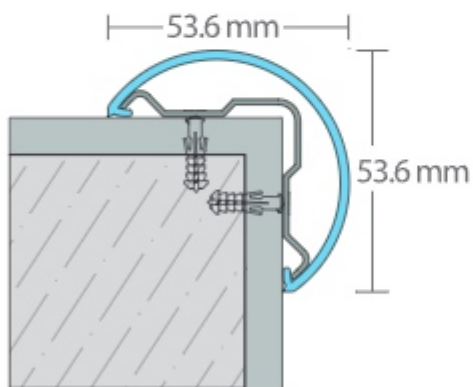

CG51

CORNER PROTECTION SYSTEM

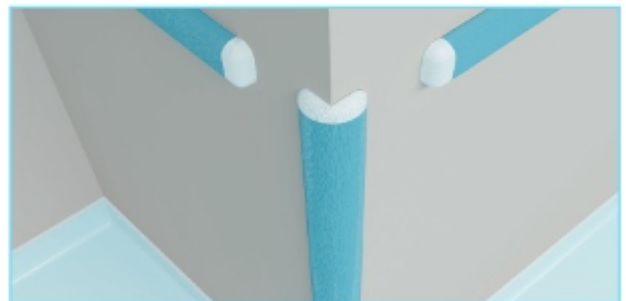

WG037
CORNER END CAP



It is a corner protection system that is used in kindergartens, dormitories and hospitals with more shock absorbing and deformation properties than other corner protections.

CG 50B

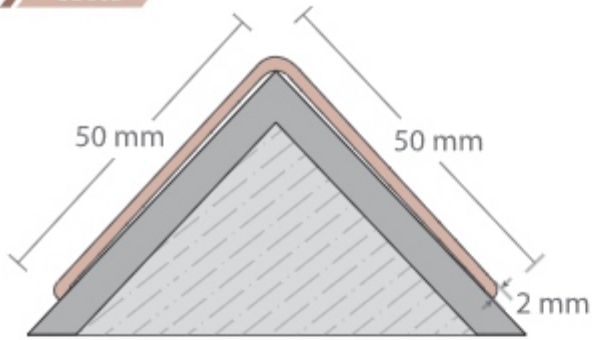

CG25B CG50B

STICK ON CORNER GUARD

CG 25B

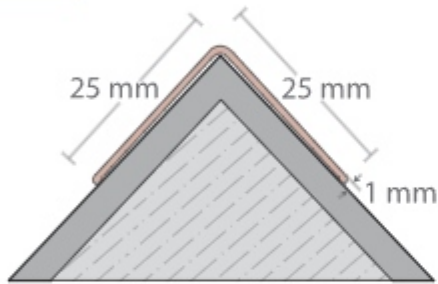

CORNER
PROTECTION
SYSTEMS

CG 25B & CG 50B are an adhesive corner protection system made of non-deformable and non-scratch vinyl with a decorative top surface, which can be used in all kinds of structures such as hospitals, shopping malls, restaurants, hotels, dormitories, universities, military buildings and public buildings to prevent deformations on the wall corners during the use of buildings. They can be used in a specific height (L: 1 m, L: 1.50 m) or it is applied with vinyl plate adhesive throughout the floor height. They are manufactured in 32 different colors.



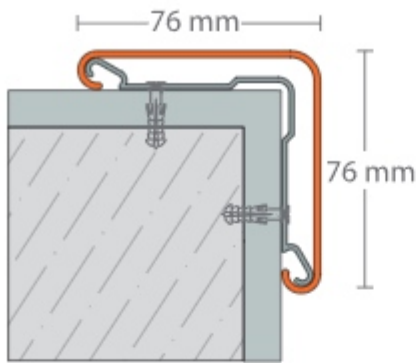

CG76

CORNER PROTECTION SYSTEM

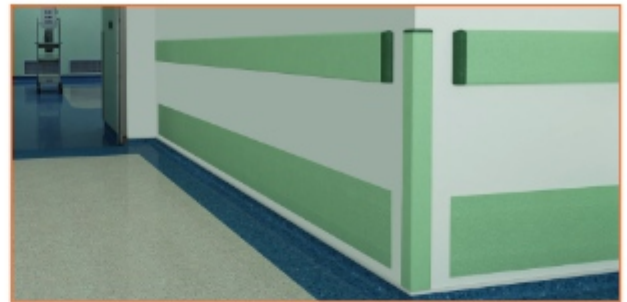

WG008 END CAP



CG76 is a vinyl over aluminum corner protection system that can be used in all kinds of buildings such as hospitals, shopping malls, hotels, dormitories, universities and public buildings to protect the corners of the walls. It can be used in a specific height (L: 1 m, L: 1.50 m) as well as throughout the floor height. It is decorative with a top end cap. It is manufactured in 32 different colors.

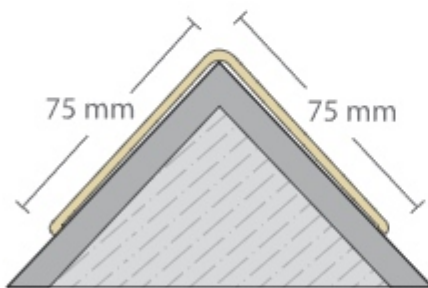

CG76B

CORNER PROTECTION SYSTEM



CG76 B is a corner protection system made of non-deformable and scratch-proof vinyl with a decorative top surface, which can be used in all kinds of buildings such as hospitals, shopping malls, restaurants, hotels, dormitories, universities, dormitories, military buildings and public buildings to prevent deformations on the wall corners during the use of buildings. It can be used in a specific height (L: 1.20 m, L: 1.50 m) as well as throughout the floor height. It is manufactured in 32 different colors.

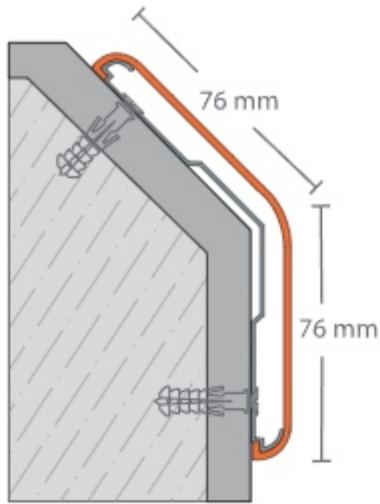

CG76A

ANGULARITY CORNER GUARD SYSTEM



CORNER
PROTECTION
SYSTEMS

CG76A 135* is a vinyl over aluminum corner protection system that can be used in all types of buildings such as hospitals, shopping malls, hotels, dormitories, universities, and public buildings to protect wall corners. It can be used in a specific height (L: 1 m, L: 1.50 m) as well as throughout the floor height. It is decorative with a top end cap. It is manufactured in 32 different colors.



WG009
CORNER END CAP

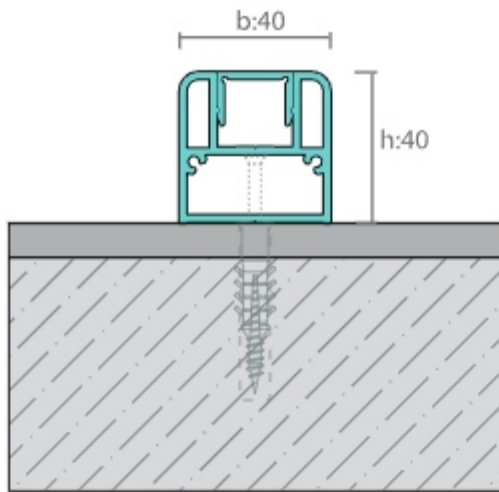

WG102

BED HEAD STOPER

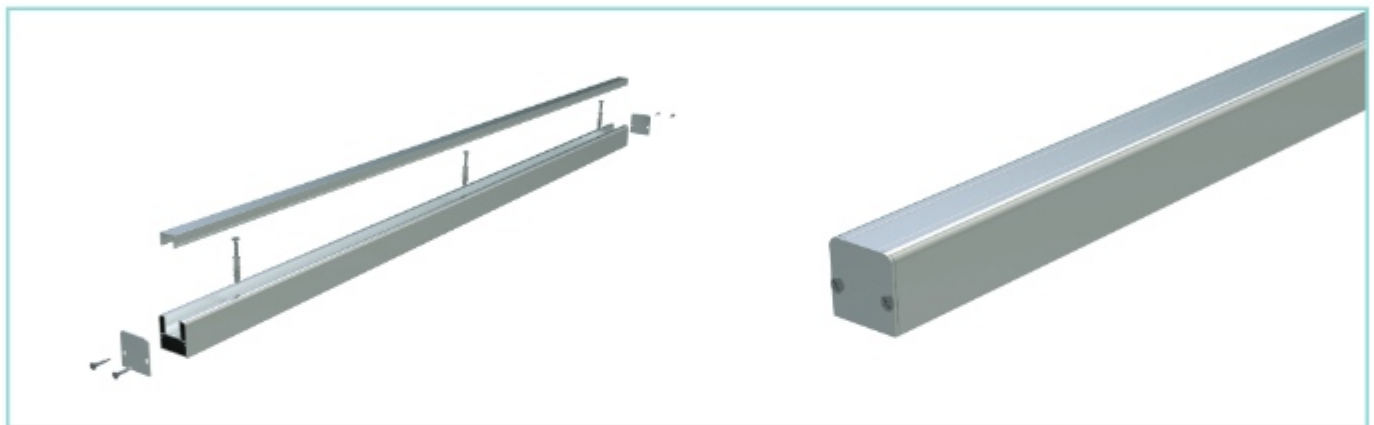

WG102 The bedhead stopper, which is fixed by screwing to the ground with its strong structure of aluminum, forms an integrity with the clips and cover that installs on it. Not only with the bedside stopper function in hospitals, but also in all intensive service vehicle traffic, food carts, clean dirty laundry carts, etc. in the shuttles where wheeled vehicles pass, provides a stopper without being hit to the wall. Aluminum bed head stopper, which is mostly produced as 1 meter for patient beds, is produced in natural anodized or ral paint colors, and it is also manufactured in 3 meter lengths for other places.



WG067 END CAP

RG150

RUBBER WALL PROTECTION SYSTEM

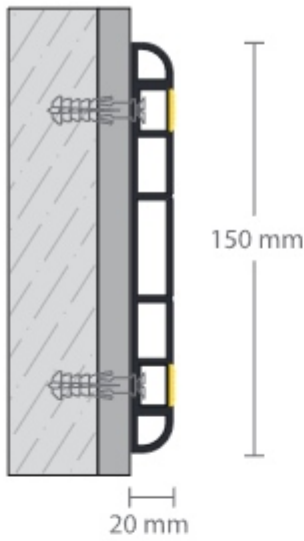

Rubber wall guard system with a width of 150 mm and a thickness of 20 mm is used in parking lots and factories or in areas where deformation can be more intense to prevent deformations that may occur on the walls. It creates a decorative appearance with its right and left end caps. Profile lengths are manufactured as 3 meters.

RUBBER & TPE
WALL PROTECTION
SYSTEM



RG01 RIGHT AND
LEFT END CAP

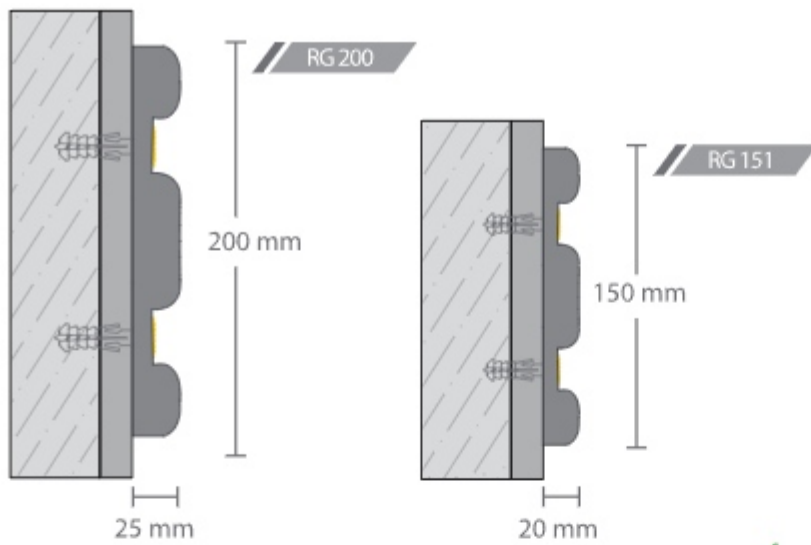

RG151 RG200

TPE WALL PROTECTION SYSTEM

- ✓ 100% Recyclable
- ✓ Does not leave traces and colors

TPE wall protection system with a width of 150 - 200 mm, thickness of 20 - 25 mm is used in parking lots, factories or in areas where deformation can be more intense to prevent deformations that may occur on the walls. It prevents areas from being damaged for many years with its strong structure. It does not cause pollution and bad appearance during application with its special formula. Profile lengths are manufactured as 3 meters. Color alternatives are black and grey.

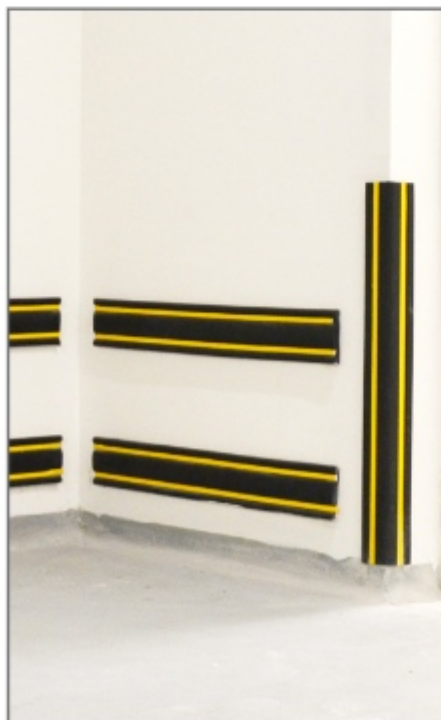

RG006 END CAP
(for RG 151)



RG004 END CAP
(for RG 200)

RG50 & RG101

TPE CORNER PROTECTION SYSTEM

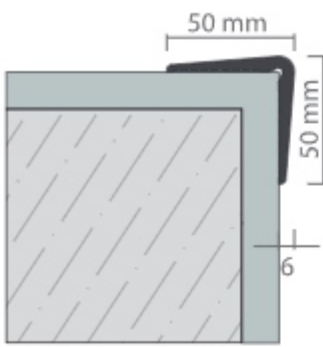

RG 50

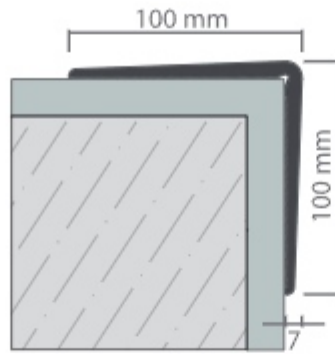

RG 101

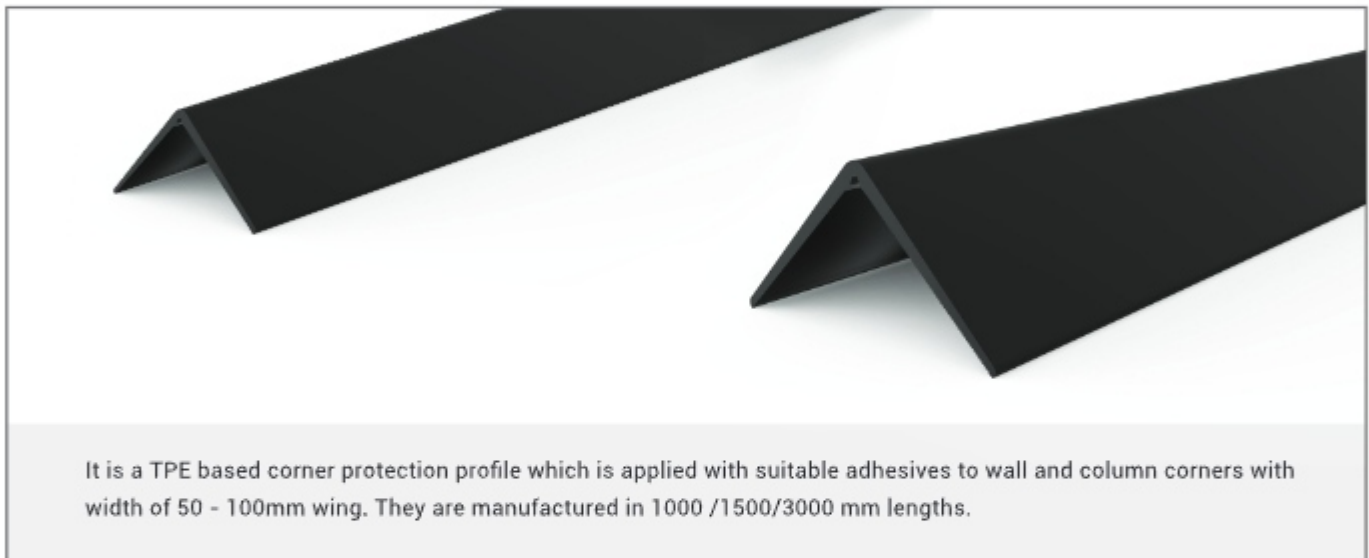

It is a TPE based corner protection profile which is applied with suitable adhesives to wall and column corners with width of 50 - 100mm wing. They are manufactured in 1000 /1500/3000 mm lengths.

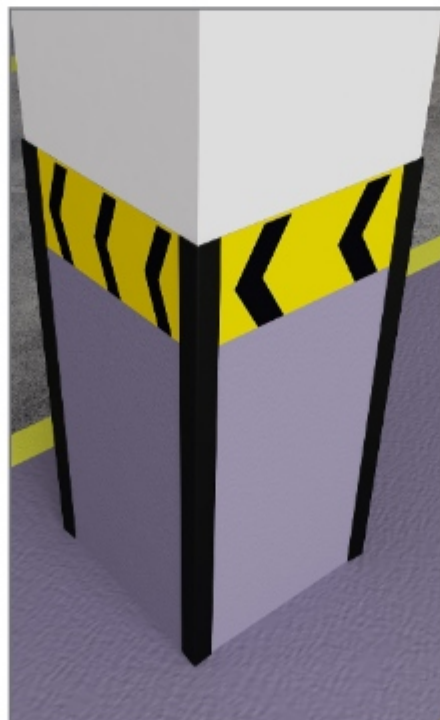

RUBBER & TPE
WALL PROTECTION
SYSTEM

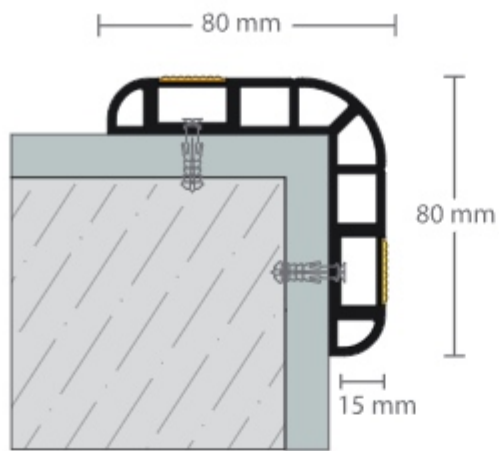

RG80

RUBBER CORNER PROTECTION SYSTEM



RG02 END CAP

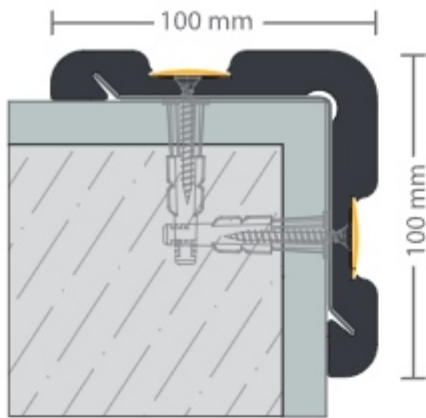

RG100

RUBBER CORNER PROTECTION SYSTEM



Used as protecting corner deformations in factories or areas where deformation may be more intense but especially in parking lots by the dimensions of 100 mm x 100 mm. Colour alternatives; black and grey. Can be used as specific length such as 1,00 mt, 1,50 mt but also can be used as standard 3 mt length. Provides straight appearance because of the TPE and continuous metal retainer.

RUBBER & TPE
WALL PROTECTION
SYSTEM

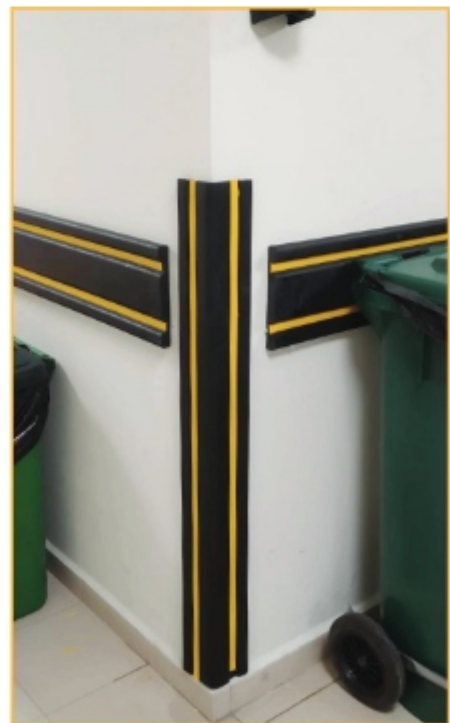

RG03 END CAP
(FOR CHAMFER COLUMNS)

HSP SERIES

HYGIENIC SKIRTING AND WALL PROTECTION

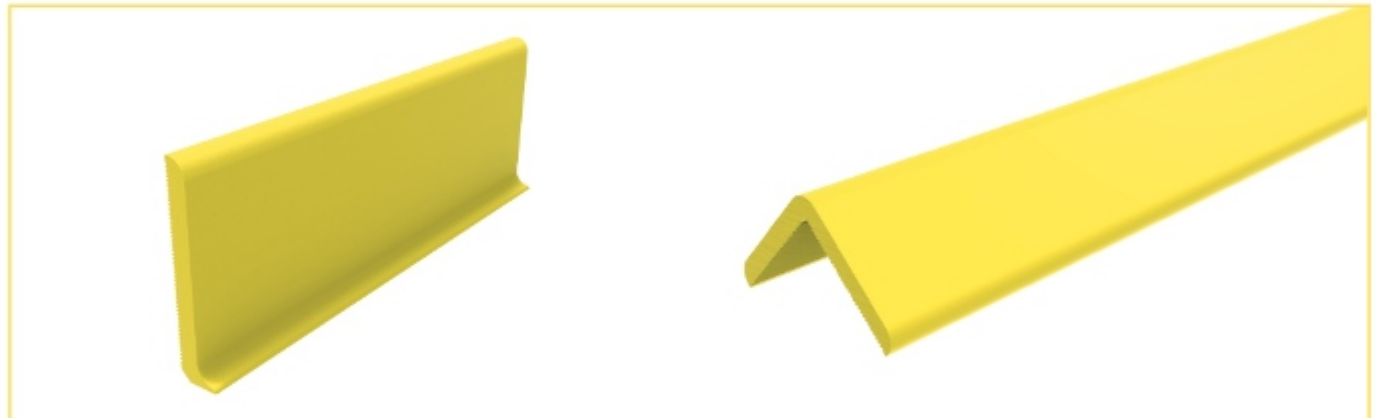
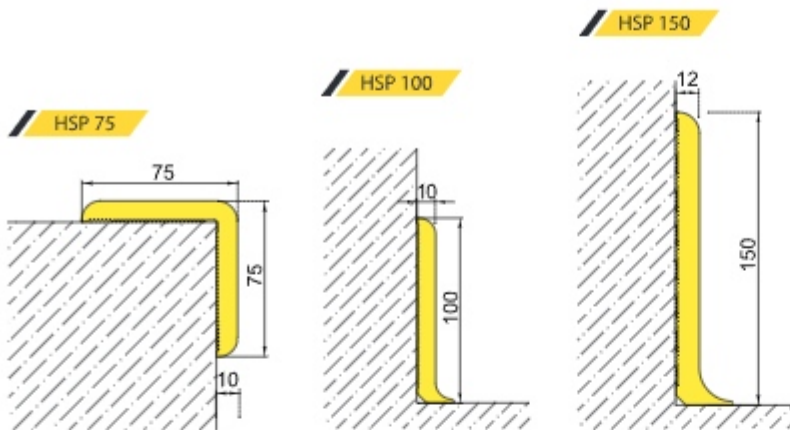

HSP Series wall corner guards and skirting boards are produced from soft hygienic PVC raw material and are produced in yellow colour to attract attention and stimulate. It is used on surfaces that should be hygienic such as dining halls, cold storage, and food facilities. It can be used easily on washable walls.



HSP 003:
HSP 100 EXTERNAL CORNER BIT

HSP SERIES

HYGIENIC SKIRTING AND WALL PROTECTION

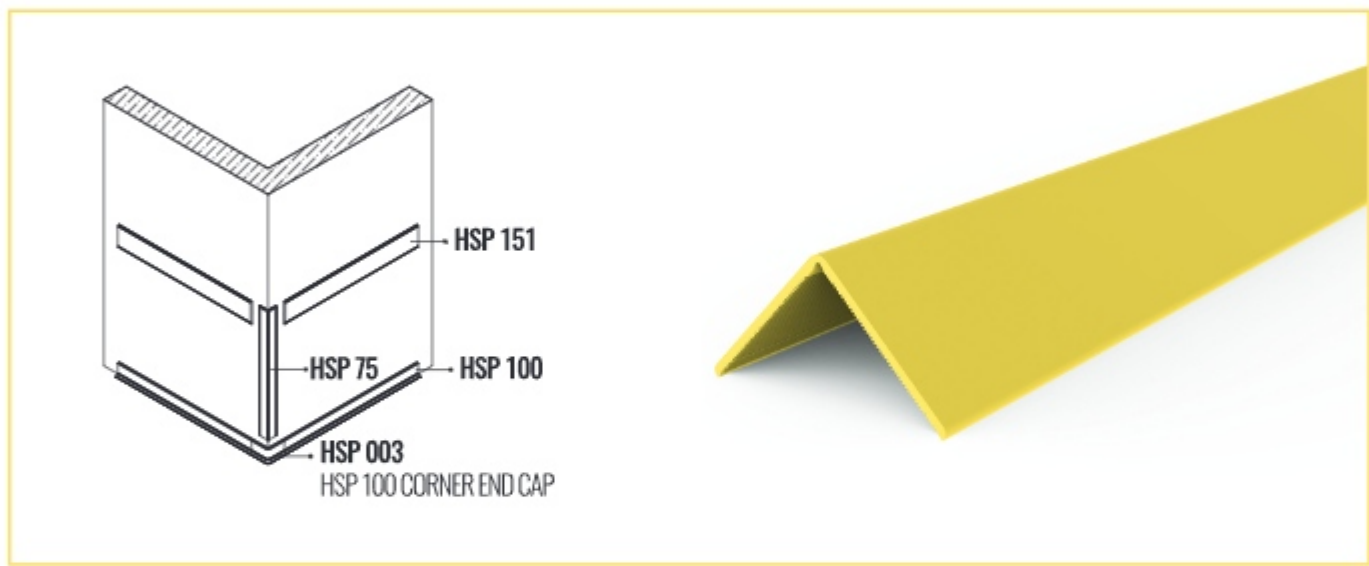
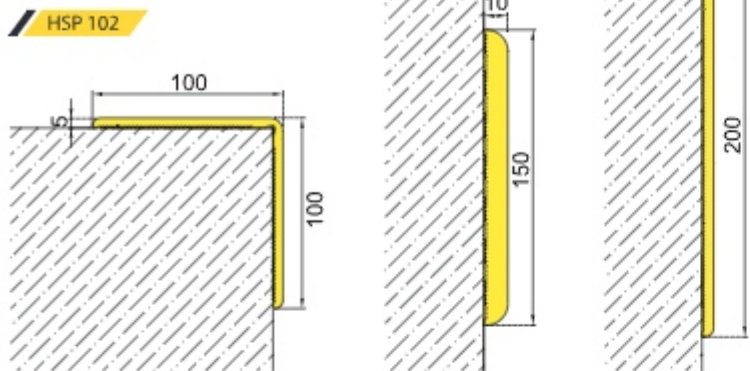

RUBBER & TPE
WALL PROTECTION
SYSTEM



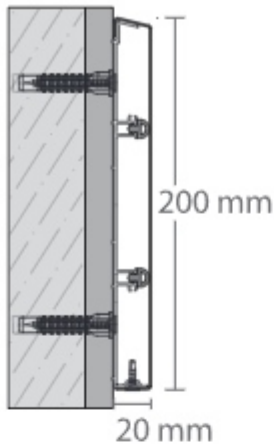

WG200 SS

STAINLESS WALL PROTECTION SYSTEM



STAINLESS DESIGN OPTIONS

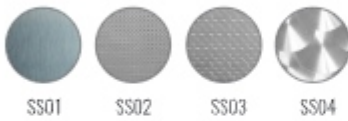

WG046 LEFT AND RIGHT END



It is a stainless wall protection band formed by attaching a 200 mm wide 1.00 mm thick 304 quality stainless sheath to aluminium carrier profiles. It absorbs the impacts thanks to the shock-absorbing wicks.

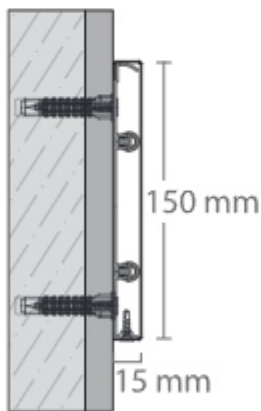

WG151 SS

STAINLESS WALL PROTECTION SYSTEM



STAINLESS DESIGN OPTIONS

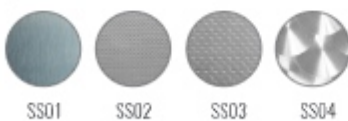

WG048 LEFT AND RIGHT END



Symmetrical 150 mm top part is connected to aluminium part with screws. It absorbs the impacts thanks to the shock absorbing wicks.

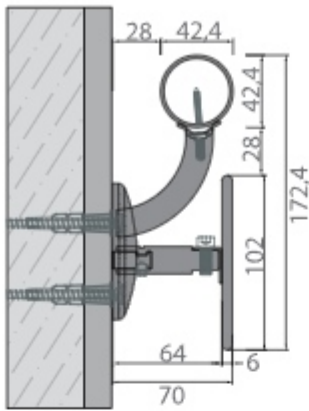

WG170 SS

STAINLESS HANDRAIL WALL PROTECTION SYSTEM



WG068 SELF BRACED ELBOW & INNER EXTERNAL CORNER



WG071 STAINLESS HANDRAIL HANDLE AND MOUNTING APPARATUS



304 The system consists of 304 quality, 6 mm thick stainless steel wall protection band and a 42 mm diameter stainless steel pipe handrail. The wall protection tape has round self-finishing and the handrail has right-left & inside outside compatible finishes. Bracelets or flush finishes are available as alternatives. Can be produced specially in project dimensions. With a single stainless steel handle, both wall protection band and handrail can be mounted at once. The system is easy to apply, hygienic, and decorative.

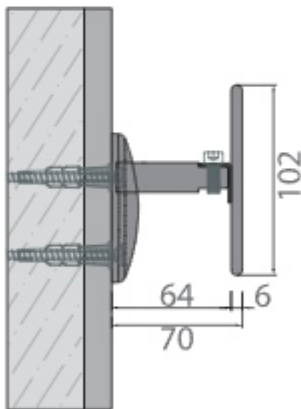

WG100 SS

STAINLESS HANDRAIL WALL PROTECTION SYSTEM



WG070 STAINLESS MOUNTING APPARATUS



This is a 304 quality stainless steel wall protection tape with a thickness of 6mm. Round design of the top provides comfortable handling. The system has a self-radius finish. Can be produced in project-specific dimensions. Stainless steel brackets are used to mount the system to the wall. The system is easy to apply, hygienic, and decorative.

STAINLESS
PROTECTION
SYSTEMS

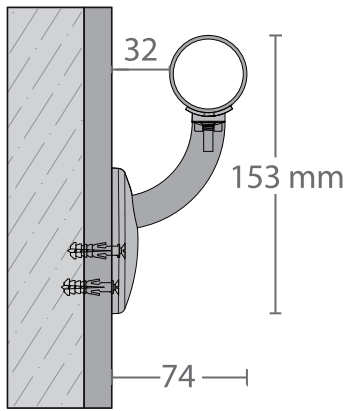

WG42 SS

STAINLESS HANDRAIL WALL PROTECTION SYSTEM

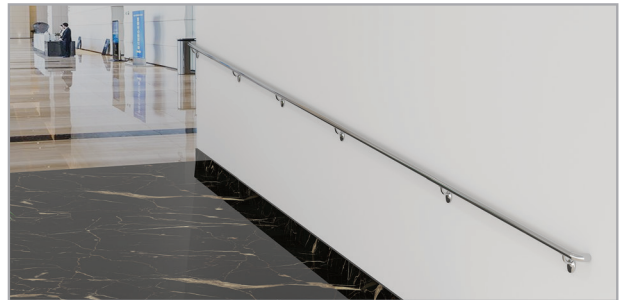

WG039 STAINLESS STEEL BRACKET



WG034 FLUSH FINISH HANDRAIL ELBOW



WG068 SELF BRACED ELBOW & INNER EXTERNAL CORNER



WG069 FLUSH INNER OUTER CORNER



WG072 PIPE COLLAR



ARFEN's 42 mm stainless steel or vinyl handrail systems are suitable to international standards with hygienic and decorative structure.

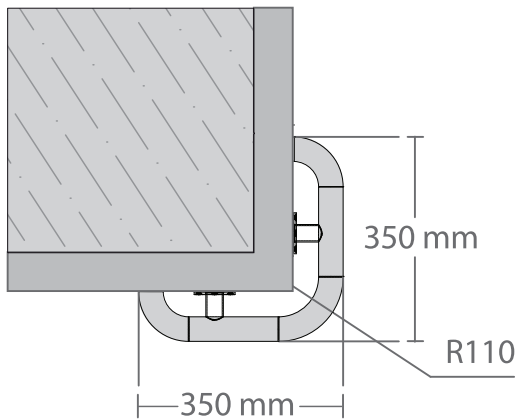

WG 502

STAINLESS HANDRAIL WALL PROTECTION SYSTEM



They are oval corner protection systems that protect the corners of walls and columns against the collisions of vehicles such as forklifts or pallet trucks in food facilities, markets and all kinds of service and load corridors.

KP SERIES

STAINLESS DOOR PROTECTION PLATES

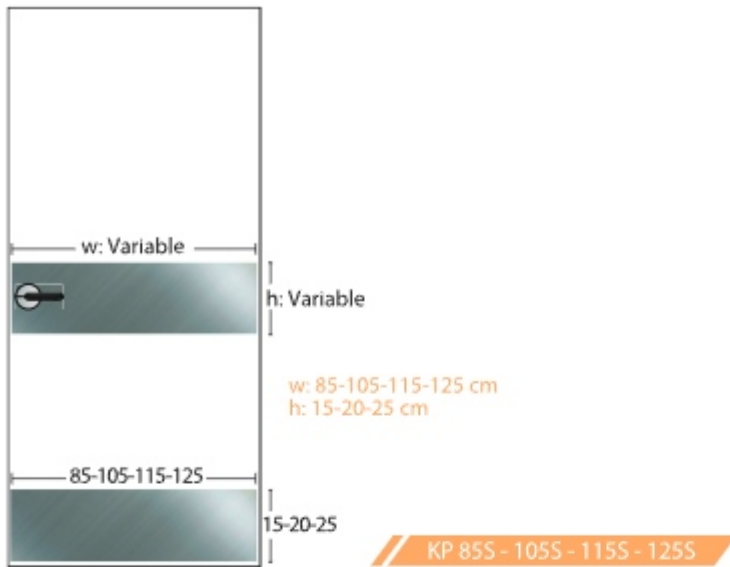

STAINLESS
PROTECTION
SYSTEMS

CG50S

STAINLESS CORNER PROTECTION SYSTEM

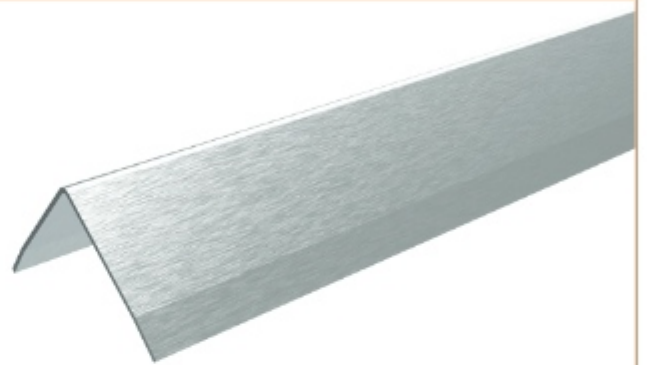
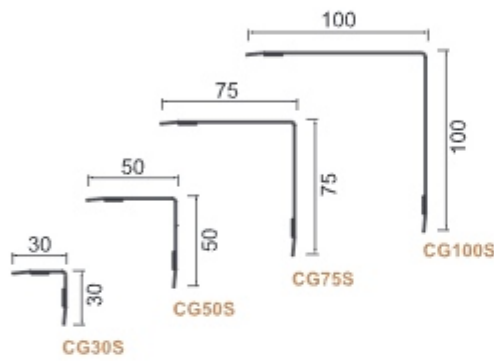
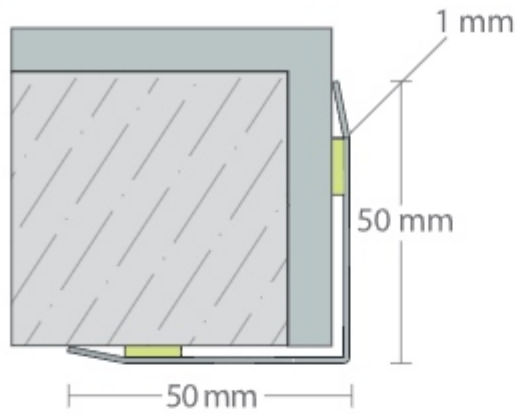

1 mm stainless corner protection profiles produced in 304 quality, which can be used in shopping malls, hotels, restaurants, schools and public buildings, adapt to the general metal effect in the space, thanks to their stainless appearance. It is resistant to impacts that may come to corners on columns and walls. It can be used at a certain height (L: 1m L: 1.50m) as well as throughout the floor height. Although it is fixed to the wall by screws, it can be applied to corner walls and column corners with polyurethane adhesives or lift-sided tapes.

WG1004 SS

STAINLESS PLATES

STAINLESS DESIGN OPTIONS



SS01 SS02 SS03 SS04



They are products that can be applied to walls with special adhesives or special end profiles made of 304 and 316 quality stainless steel with 1000 mm, 1250 mm, 1500 mm width t:1.00 mm thickness. And are hygienic, fireproof and stainless wall protection plate products that can be used in all kinds of buildings such as shopping malls, hospitals, metro stations, and food and health facilities.

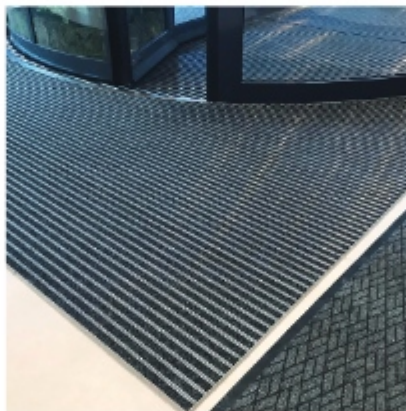
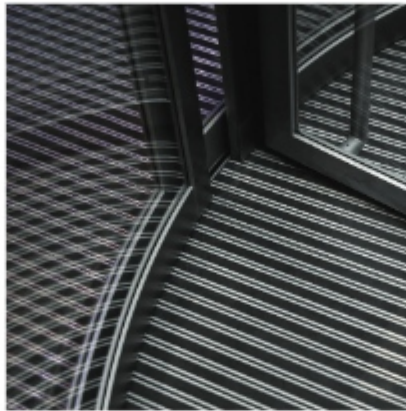
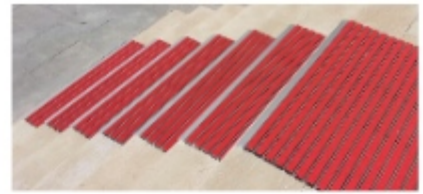

www.arfen.com

**ENTRANCE
MAT SYSTEMS**

 **ARFEN®**

ENTRANCE
MAT SYSTEMS



HH 01

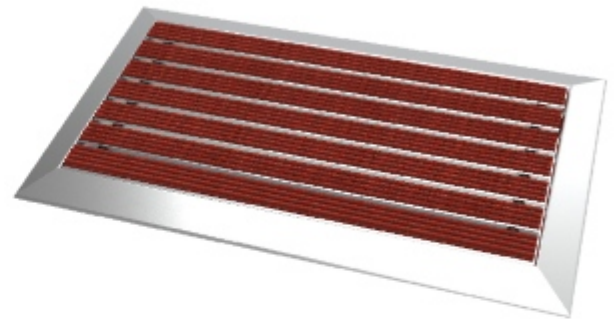
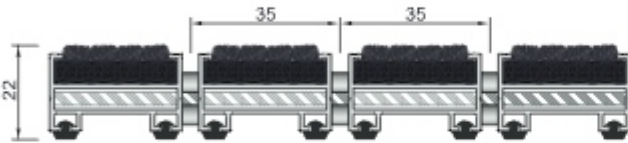

HH 01 Aluminium Mat System

It is an indoor matting system that traps dirt and mud thanks to aluminium profiles with carpet top surfaces. The long-lasting mat system, which is connected to each other with steel ropes, can be framed or produced in a pool type that fits into a certain space. Its depth is 2 cm. It provides sound insulation thanks to its bottom wicks.

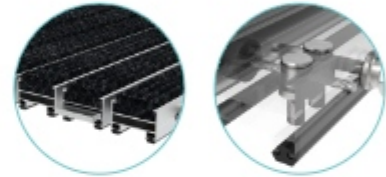

HS 02

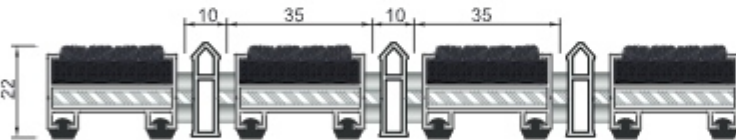

HS 02 Aluminium Mat System

It is an indoor matting system that traps dirt and mud due to aluminium profiles and aluminium scrapers with a carpet top surface. The long-lasting mat system, connected to each other with steel ropes, can be framed or produced in a pool type that fits into a particular space. Its depth is 2 cm. It provides sound insulation thanks to its bottom wicks.

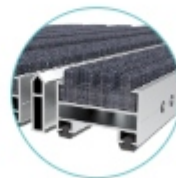

Carpet Colours



They can be produced in special sizes.

Standard framed types are (40x70), (50x80), (60x90) cm.

► FLYMAT 008
STANDARD SERIES
FRAME PROFILE



► FLYMAT 026
STANDARD SERIES FLUSH
TYPE POOL SIDE PROFILE



► MB2515
TOP TYPE
POOL SIDE PROFILE



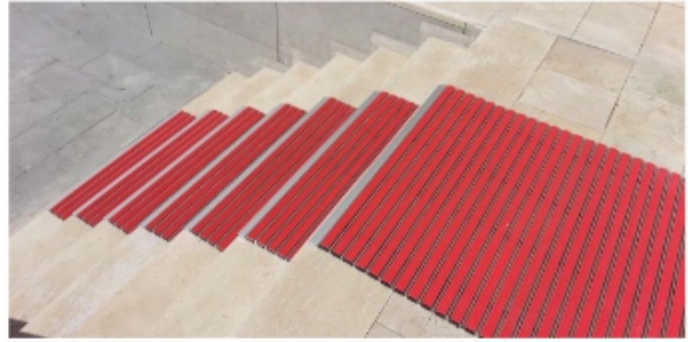

HF 03

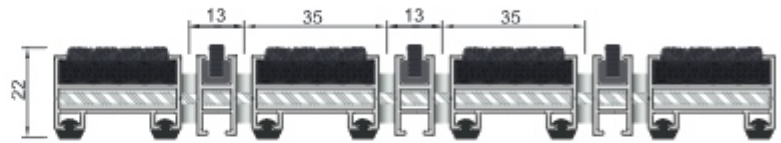
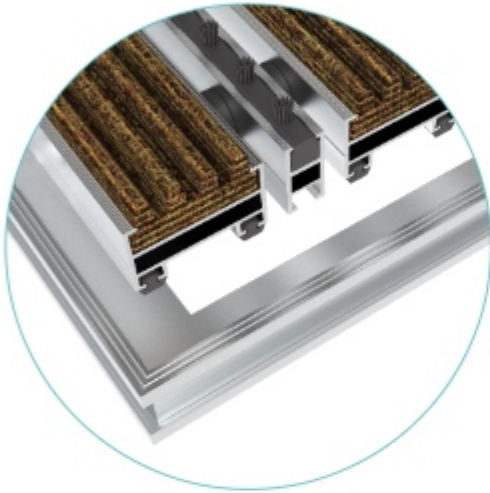

HF 03 Aluminum Mat System

It is an indoor matting system that traps dirt and mud thanks to aluminium profiles and brush scrapers with a carpet top surface. The long-lasting mat system, connected to each other with steel ropes, can be framed or produced in a pool type that fits into a particular space. Its depth is 2 cm. It provides sound insulation due to its bottom wicks.

HH 04

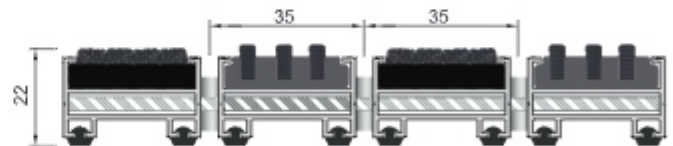

HH 04 Aluminum Mat System

It is an indoor matting system that traps dirt and mud thanks to aluminium profiles and cassette brushes with carpet top surfaces. The long-lasting mat system, connected to each other with steel ropes, can be framed or produced in a pool type that fits into a particular space. Its depth is 2 cm. It provides sound insulation due to its bottom wicks.

ENTRANCE
MAT SYSTEMS

Carpet Colours



Black



Grey



Red



Camel Hair

KK 06

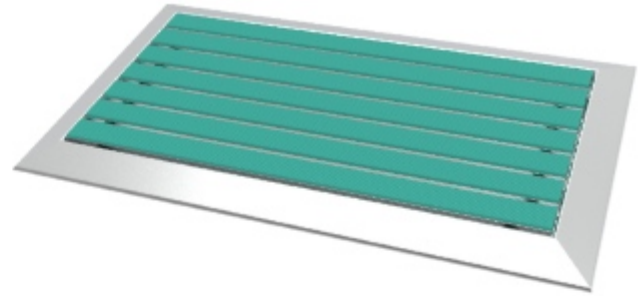
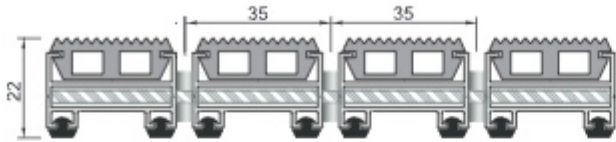

KK 06 Aluminium Mat System

It is an outdoor matting system that keeps dirt and mud on aluminium profiles by means of rubber strips. The long-lasting mat system, connected to each other with steel ropes, can be framed or produced in a pool type that fits into a particular space. Its depth is 2 cm. It provides sound insulation due to its bottom wicks.

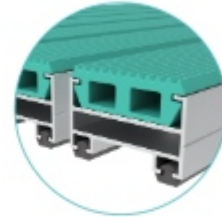

KS 07

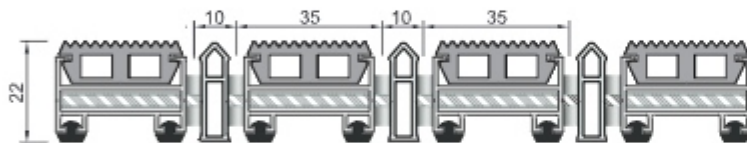

KS 07 Aluminium Mat System

It is an outdoor matting system that traps dirt and mud thanks to rubber-striped aluminium profiles and scrapers. The long-lasting mat system, connected to each other with steel ropes, can be framed or produced in a pool type that fits into a particular space. Its depth is 2 cm. It provides sound insulation thanks to its bottom wicks.

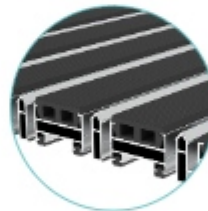

KF 07

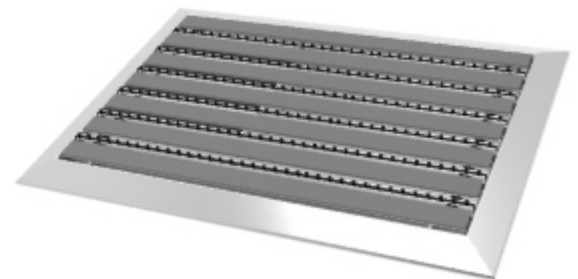
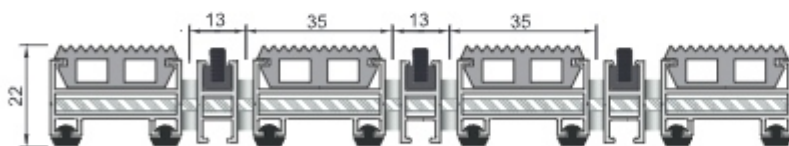

KF 07 Aluminium Mat System

It is an outdoor matting system that traps dirt and mud thanks to rubber-striped aluminium profiles and brush scrapers. The long-lasting mat system, connected to each other with steel ropes, can be framed or produced in a pool type that fits into a particular space. Its depth is 2 cm. It provides sound insulation thanks to its bottom wicks.

"Standard colors for rubber are black and gray and can be produced in various colors."

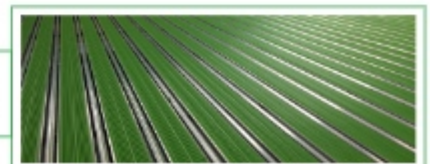

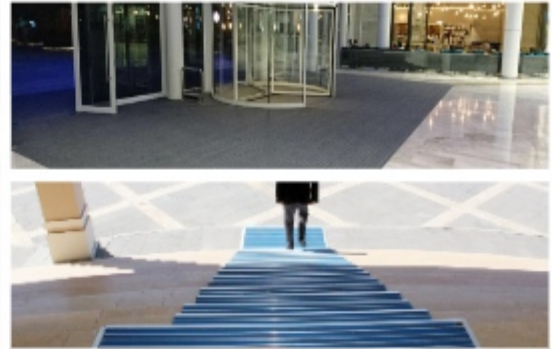

KF 08

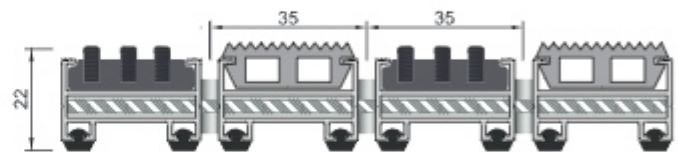

KF 08 Aluminum Mat System

It is an outdoor matting system that traps dirt and mud thanks to rubber-striped aluminium profiles and cassette brushes. The long-lasting mat system, connected to each other with steel ropes, can be framed or produced in a pool type that fits into a particular space. Its depth is 2 cm. It provides sound insulation thanks to its bottom wicks.

KF 09

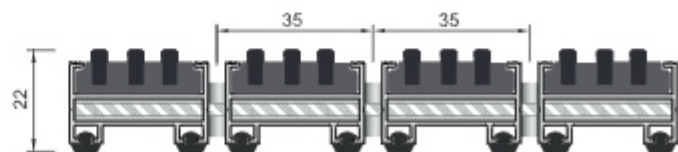

KF 09 Aluminum Mat System

Due to the cassette brushed aluminium profiles, dirt is an outdoor matting system that traps mud. The long-lasting mat system, connected to each other with steel ropes, can be framed or produced in a pool type that fits into a particular space. Its depth is 2 cm. It provides sound insulation thanks to its bottom wicks.

HH 05

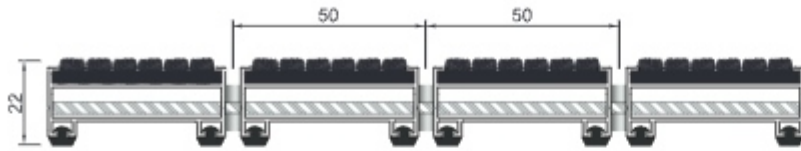
**HH 05 Aluminium Mat System**

It is an indoor matting system that traps dirt and mud thanks to aluminium profiles with a wide carpet surface. The long-lasting mat system, connected to each other with steel ropes, can be framed or produced in a pool type that fits into a particular space. Its depth is 2 cm. It provides sound insulation thanks to its bottom wicks.

HH 06

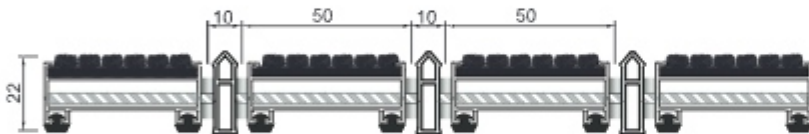
**HH 06 Aluminium Mat System**

It is an indoor matting system that holds dirt and mud thanks to wide carpet surface aluminium profiles and scrapers. The long-lasting mat system, connected to each other with steel ropes, can be framed or produced in a pool type that fits into a particular space. Its depth is 2 cm. It provides sound insulation due to its bottom wicks.

HH 07

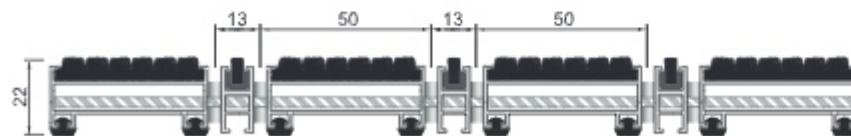
**HH 07 Aluminium Mat System**

It is an indoor matting system that holds dirt and mud thanks to wide carpet top surface aluminium profiles and brush scrapers. The long-lasting mat system, connected to each other with steel ropes, can be framed or produced in a pool type that fits into a particular space. Its depth is 2 cm. It provides sound insulation due to its bottom wicks.

Carpet Colours



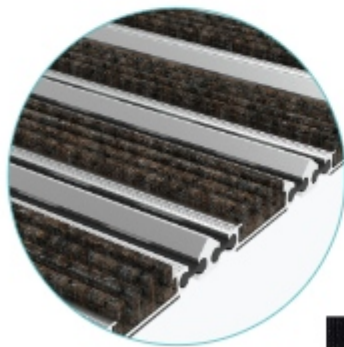
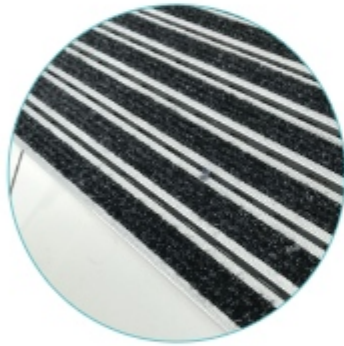
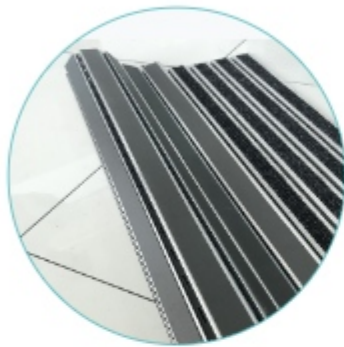

T01

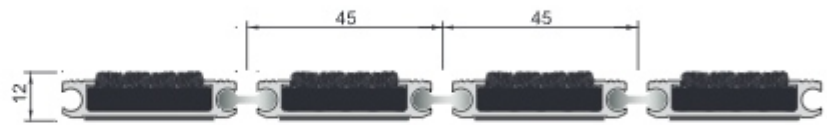

T01 Thin Series Carpet Top Surface Mat System

It is a long-lasting indoor mat system that can be rolled and can hold dirt and dust with its low height and perforated PVC connection profiles. Its depth is 12 mm. They can be produced as recessed and framed types.

T02

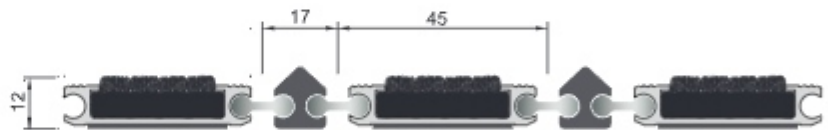

T02 Thin Series Carpet + Scraper Top Surface Mat System

They are indoor matting systems that reduce the dirt on the substrate with their perforated PVC profiles that can hold a high amount of dust and dirt thanks to their scraper profiles.

- Carpet Colours
-  Black
 -  Grey
 -  Red
 -  Camel Hair

» FLYMAT 022
THIN SERIES
FRAME PROFILE



» FLYMAT 027
THIN SERIES FLUSH
TYPE POOL SIDE PROFILE



» MB2515
TOP TYPE
POOL SIDE PROFILE



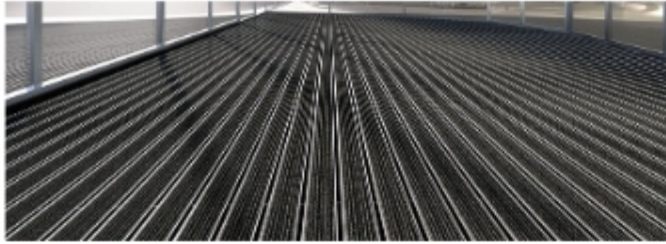

T03

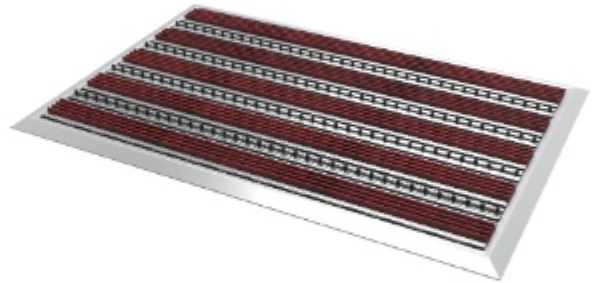
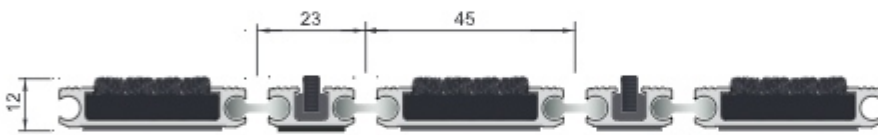

T03 Carpet + Brush Top Surface Mat System
They are thin series aluminium mat systems with carpet + brush top surface. They are decorative and long-lasting mat systems that can hold dust and dirt.

T04

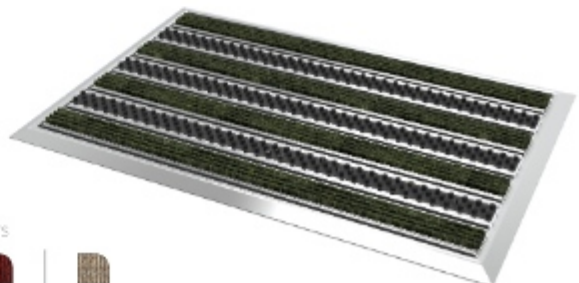
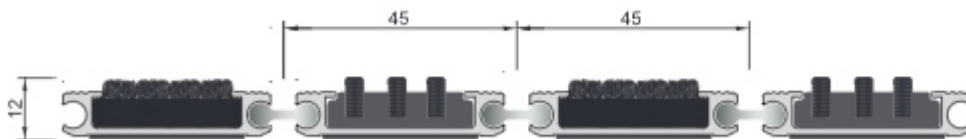

T04 Carpet + Entrance Mat System with Cassette Brushed Top Surface
An indoor matting system with carpet + cassette brush that can hold dust and dirt, suitable for heavy pedestrian traffic.

- Carpet Colours
- 
Black
 - 
Grey
 - 
Red
 - 
Camel Hair

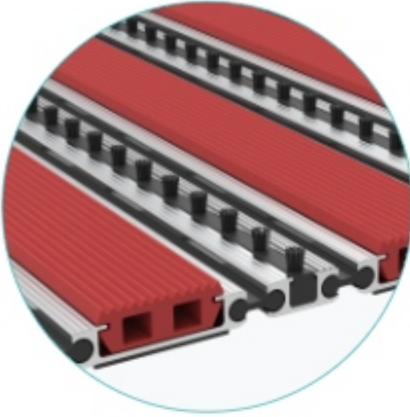

T05

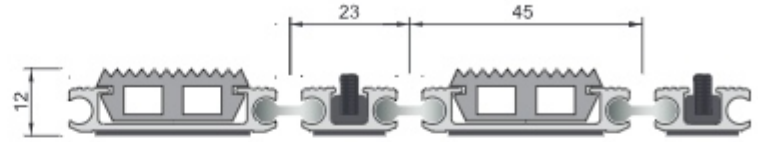
**T05 Rubber + Brush Top Surface Entrance Mat System**

A thin series outdoor matting system. It holds dust due to brush scrapers and mud thanks to rubber wicks. It is long-lasting and decorative.

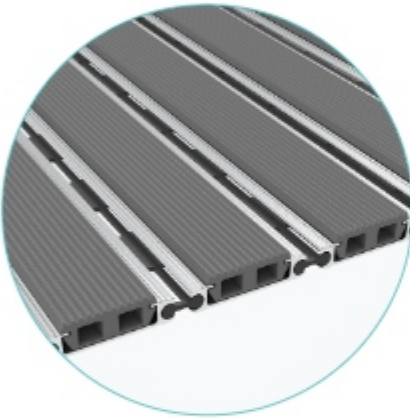

T06

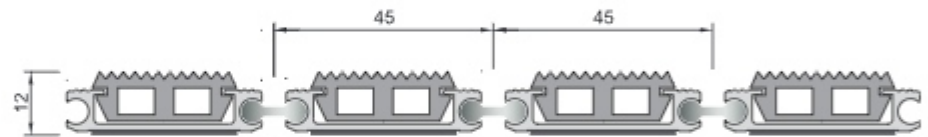
**T06 Thin Series Rubber Surface Mat System**

They are aluminum outdoor mat systems with a rubber top surface that can hold dirt and mud with their low height and perforated PVC connection profiles.

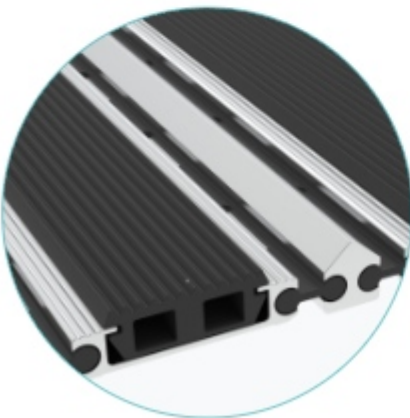

T07

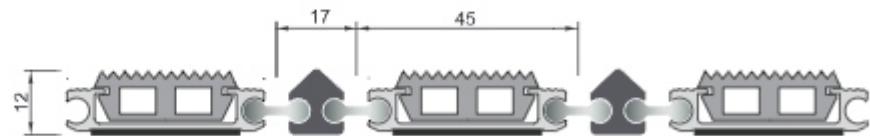
**T07 Rubber + Scraper Top Surface Mat System**

They are outdoor matting systems that can hold dirt and mud in areas subject to heavy pedestrian traffic.



T08

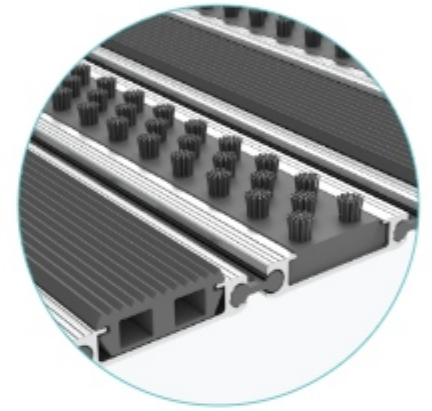
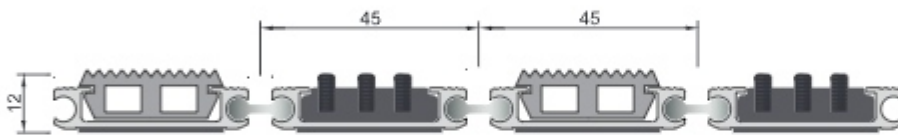

T08 Thin Series Mat System with Rubber Roving and Cassette Brush

It is a durable and long-lasting mat system used in areas where mud and dirt are intense.

T09

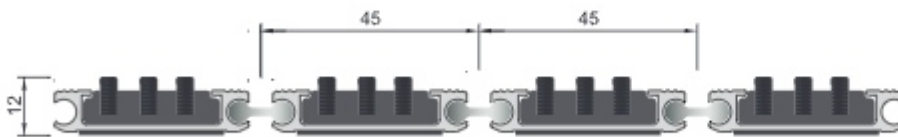

T09 Cassette Only Brush Mat System

They are outdoor matting systems that are resistant to heavy pedestrian traffic, can hold dirt and mud at a high rate due to their decorative and long-lasting cassette brushes.



» FLYMAT 008
STANDARD
SERIES FRAME
PROFILE



» FLYMAT 022
THIN SERIES
FRAME PROFILE



» FLYMAT 026
STANDARD SERIES FLUSH
TYPE POOL SIDE PROFILE



» FLYMAT 027
THIN SERIES FLUSH
TYPE POOL SIDE
PROFILE



» MB2515
TOP TYPE
POOL SIDE PROFILE

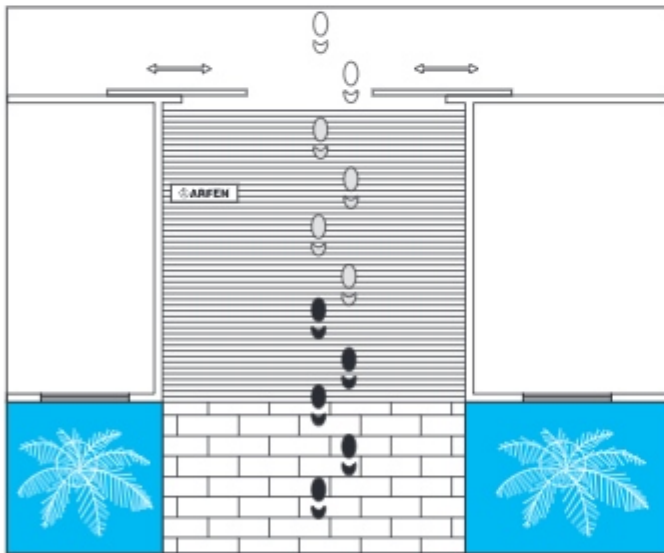

For Custom Size When Ordering

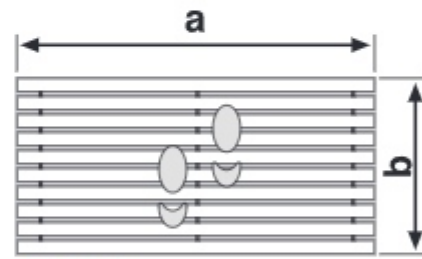

a: Mat width
b: Walking area size

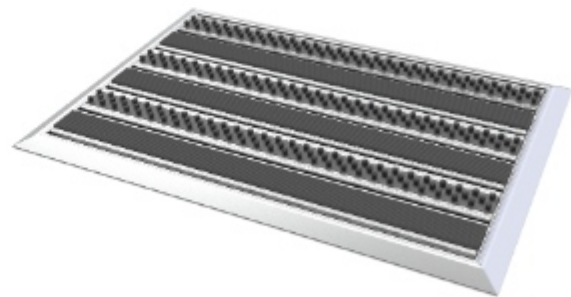

ENTRANCE
MAT SYSTEMS

Order Type Selection

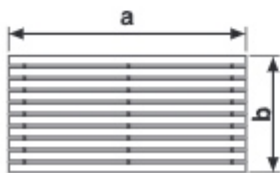

TYPE 1
Pool Type

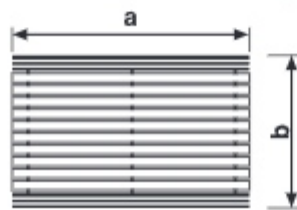

TYPE 3
Double Edge Profile

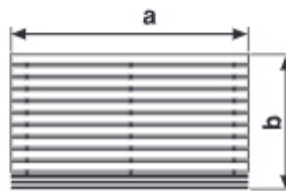

TYPE 2
Single Edge Profile

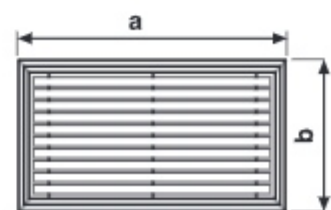

TYPE 4
Framed

1. Zone: Coarse Dirt Zone:

The first coarse dirt is cleaned with the help of a rubber and brush mat. These mats are suitable for outdoors.

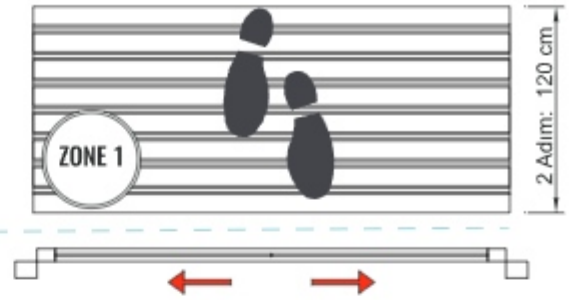
**2. Zone: Fine Dirt Zone:**

Fine dirt is cleaned with the help of a rubber and brush mat. These mats are suitable for indoor and outdoors.

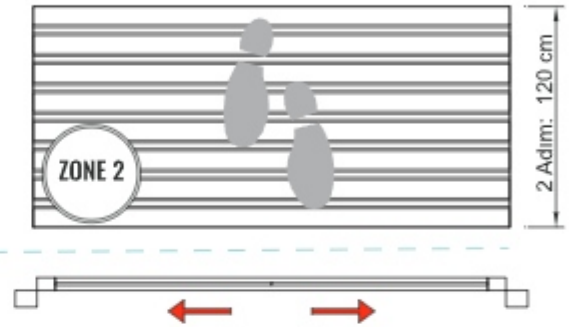
**3. Zone: Humidity Zone:**

Remaining dirt and moisture are cleaned with the help of carpet mat. Thus, footprints are prevented and a clean entrance is ensured.

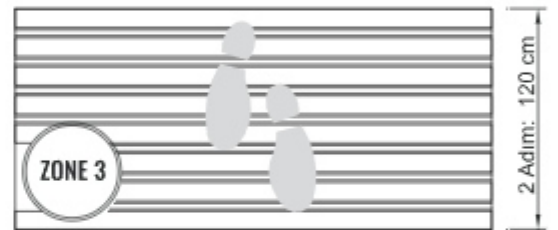
**3-ZONE MAT SYSTEM**

The first step in maintaining hygiene in public areas is through mats. Mats that keep our spaces free of dirt and grime, while creating clean areas of use, also provide the opportunity to use adjacent floor coverings for a longer period of time. Arfen's 3-Zone Mop System brings together the right parts and turns into a solution where perfect harmony is achieved. In this system, the longer the walking zone, the higher the cleaning rate. With the six-step rule at the entrance, it reduces dirt and dust up to 90% and positively affects cleaning costs. With its non-slip feature, it prevents accidents and absorbs sound.

Due to the profile and color options that are compatible with the existing architecture, many architectural and technical details have resulted in success, and we, as Arfen, continue to produce solutions in special projects.

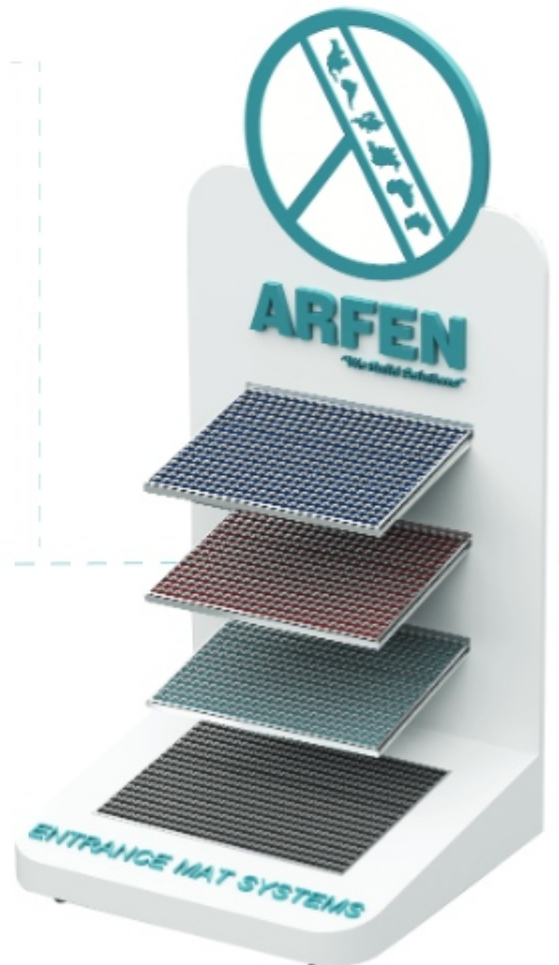
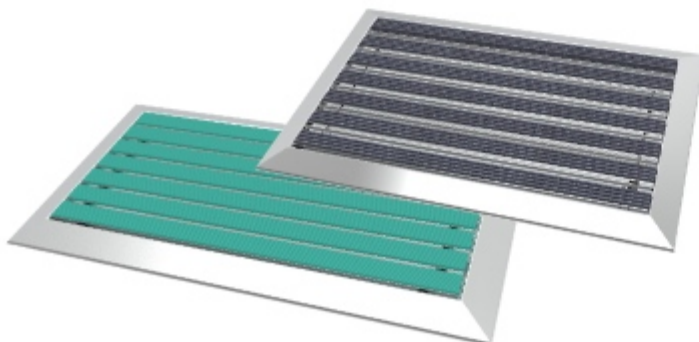

ARFEN DEHUMIDIFIER MAT SYSTEMS

It has the feature of keeping the dust and moisture on the feet indoors. It does not leak water to the bottom. It has a PVC base that prevents the product from slipping and protects the floor from dirt.

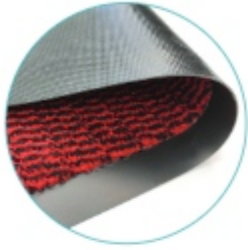

Leila 42

Product Code	a (Mat Width)	b (Step Distance)
Leila 42 Red	60 cm	40 cm

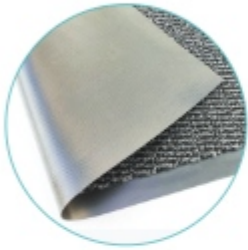

Leila 51

Product Code	a (Mat Width)	b (Step Distance)
Leila 51 Grey	60 cm	40 cm
Leila 51 Grey	90 cm	60 cm
Leila 51 Grey	150 cm	90 cm
Leila 51 Grey	120 cm	Desired Length

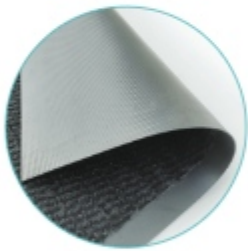

Leila 55

Product Code	a (Mat Width)	b (Step Distance)
Leila 55 Black	60 cm	40 cm
Leila 55 Black	90 cm	60 cm
Leila 55 Black	150 cm	90 cm



Arco 55

Product Code	a (Mat Width)	b (Step Distance)
Arco 55 Anthracite	90 cm	60 cm
Arco 55 Anthracite	150 cm	90 cm



Granati 40

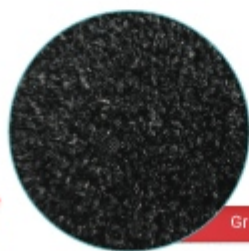

Granati 50

Granati 40 & Granati 50

Product Code	a (Mat Width)	b (Step Distance)
Granati 40	200 cm	Desired Length
Granati 50	200 cm	Desired Length



EXAMPLES OF APPLICATIONS





www.arfen.com

**ALUMINIUM &
PVC SKIRTINGS**

 **ARFEN**[®]

ALUMINIUM
& PVC
SKIRTINGS



FLAT SURFACE RADIUS ALUMINIUM SKIRTING BOARDS

50, 60, 80, 100, 120, 150 mm high aluminium baseboards that can be applied by adhering or tightening. ASP 82-92-100-120 Series have right, left, end and inner outer corner elements. It is produced from aluminium.



ASP 100 FINISHING ELEMENTS

ASP10
Right End &
Outside Corner



ASP11
Left End &
Outside Corner



ASP12
Inner
Corner



It is produced from aluminium. It is painted in the desired colour.

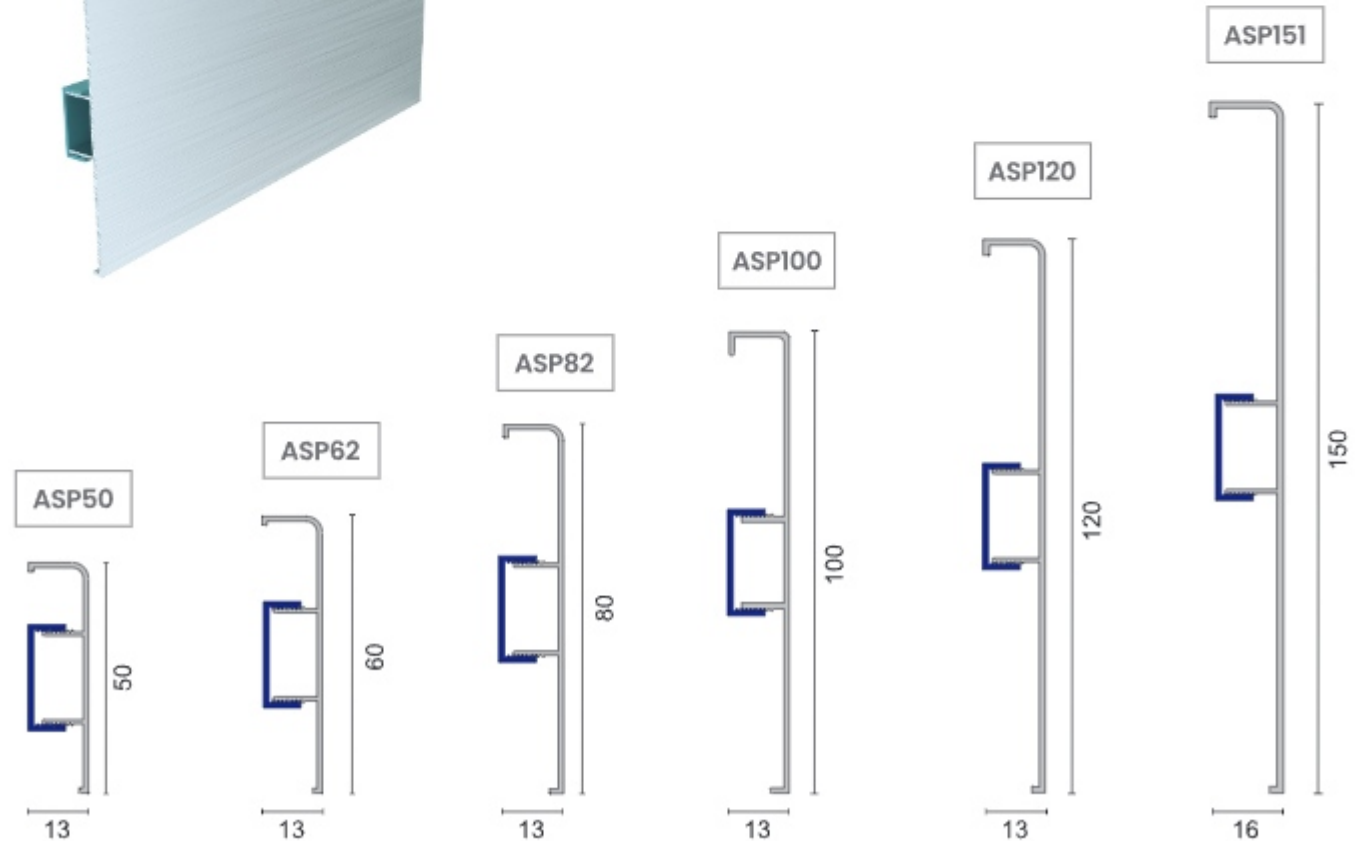

Each product has right, left, inner and outer corners made of aluminium.

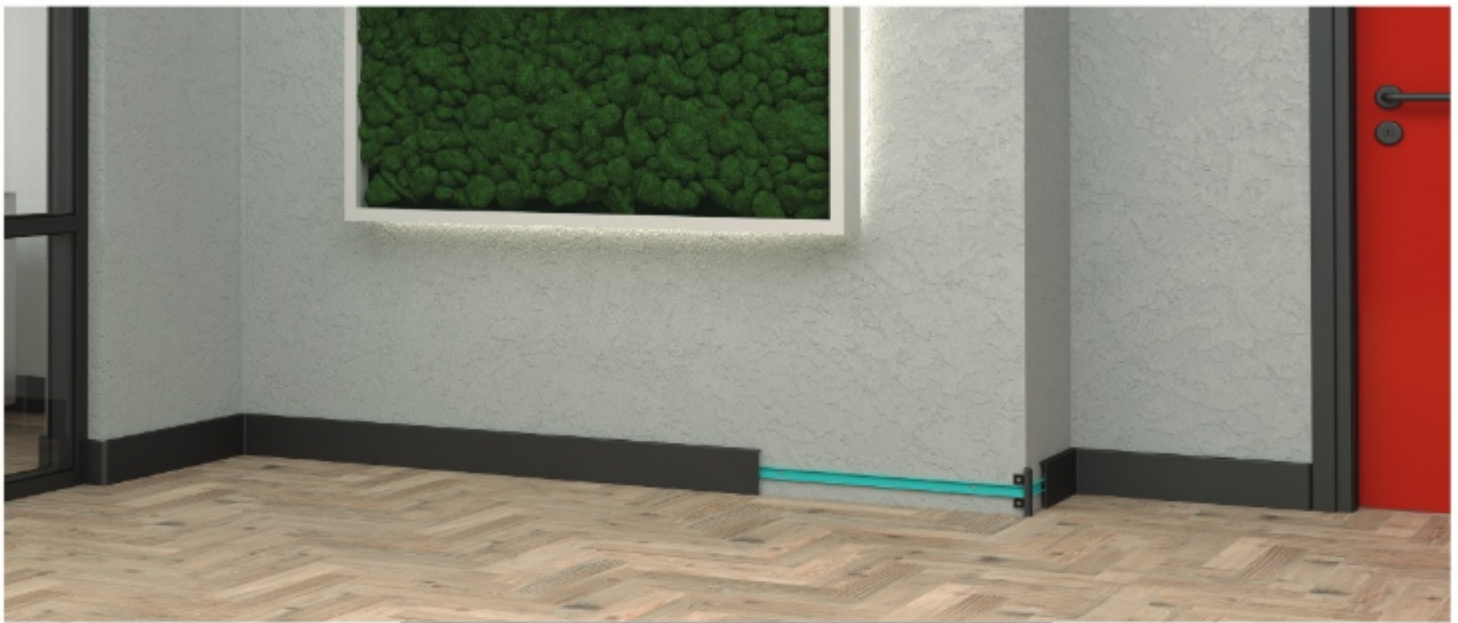

IMPLEMENTATION STEPS

1

A mounting template is made with the plastic mounting apparatus and small baseboard pieces. It is placed on the surface. Marking is done through the guide holes.



2

Plastic mounting apparatus is placed by paying attention to the marked holes. It is fixed to the wall with 4x40 YHB screws or staples. It is fixed to the wall.



3

The baseboard, which is positioned according to the nails of the mounting apparatus, is pressed flat.



4

The assembly is completed by mounting the inner - outer corner and end parts.





STICK ON SCREW TYPE THIN SERIES SKIRTING BOARDS

They are aluminium baseboards with a height of 50,60,80,85,90 mm that can be applied with adhesive or screws.

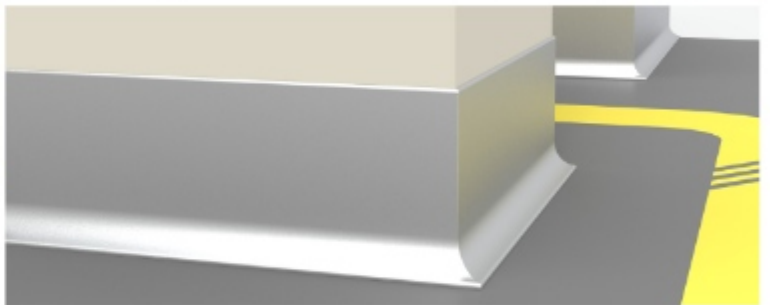

ASP51

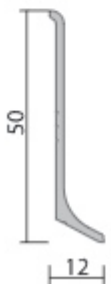

ASP61

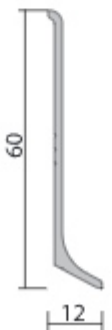

ASP81

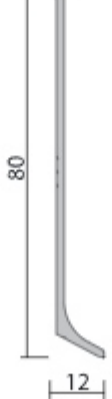

ASP85

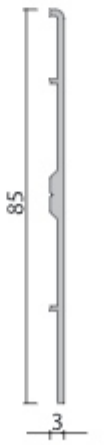

ASP91

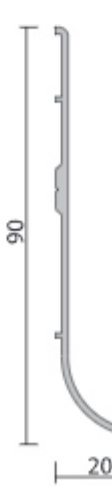

ASP101





CHAMFERED SKIRTING BOARDS

They are aluminium baseboards that can be applied with glue or screw at 60, 80, and 120 mm height. There are right-left end and inner-outer corner elements in the ASP 80 series. It is produced from PVC.

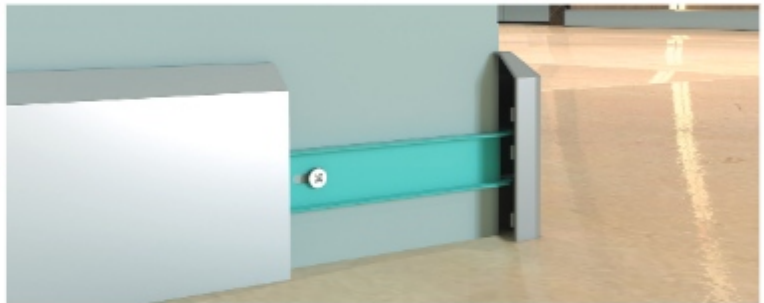

ASP 80 FINISHING ELEMENTS

ASP03 Outer Corner	ASP04 Right End	ASP05 Left End	ASP06 Inner Corner
--------------------------	--------------------	-------------------	--------------------------

It is produced from PVC and painted in aluminum color.

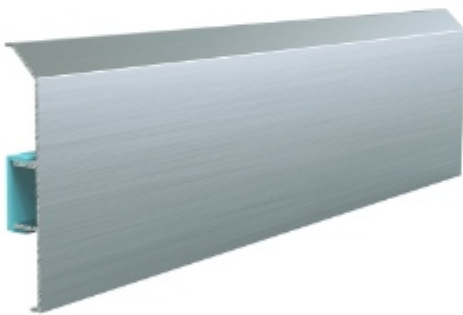

ASP60

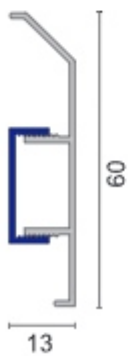

ASP75

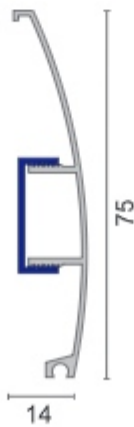

ASP80

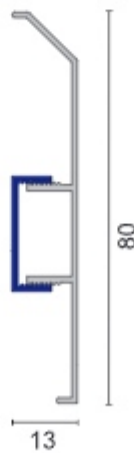

ASP121

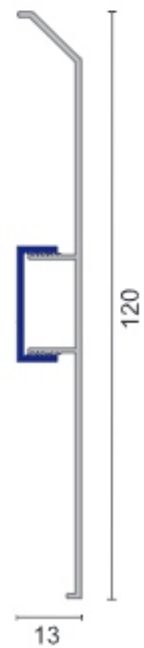

ALUMINIUM & PVC SKIRTINGS



FUGA NAIL SKIRTING BOARDS

They are aluminium skirting boards with a height of 70,94 mm that can be applied with adhesive or screws.



ASP71



ASP94

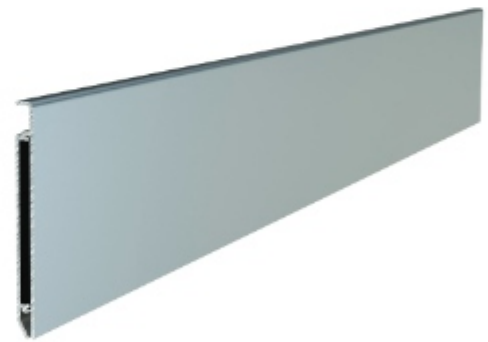
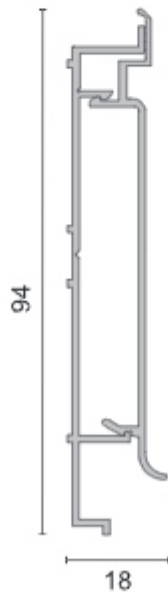

ASP 71 Aluminium is ideal for door frame applications.



DECORATIVE SKIRTING BOARDS

130 mm and 150 mm height mounted with sub-carrier system removable when needed and thanks to the flexible bottom PVC insert, tolerant of minor elevation differences and and silicone-free decorative is a skirting system. Corner parts aluminum injection It can be painted with the same color electrostatic paint.

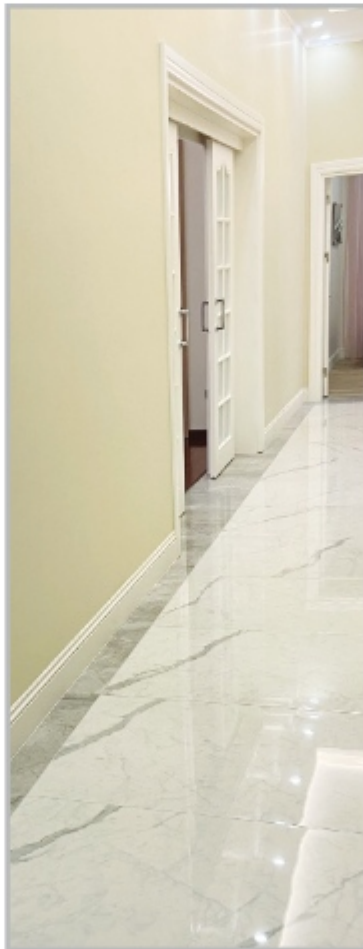
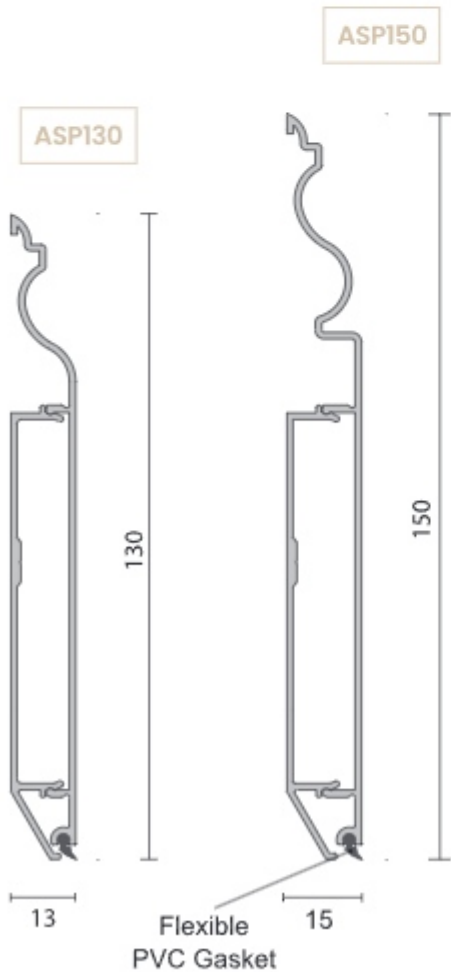
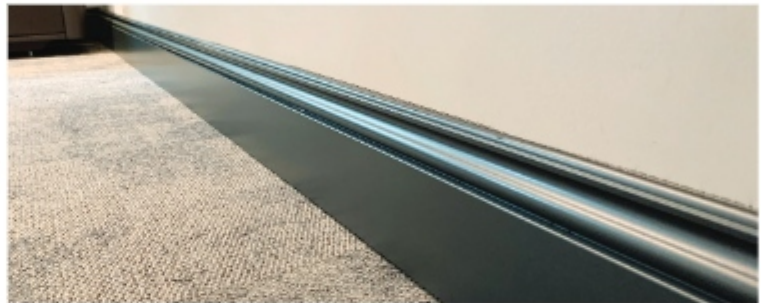

ALUMINIUM & PVC SKIRTINGS



PVC SKIRTINGS

These are PVC baseboards with a height of 45,53,80,100 mm that can be applied with adhesive or screws.



PS45

PS53

ASP80P

DC101

ASP80P FINISHING ELEMENTS

	ASP03 outer corner		ASP04 right end		ASP05 left end		ASP06 inner corner
--	-----------------------	--	--------------------	--	-------------------	--	-----------------------

It is produced from PVC and painted in aluminium colour.

DC101 FINISHING ELEMENTS

	DC019 right end		DC020 left end		DC021 outer corner		DC022 inner corner
--	--------------------	--	-------------------	--	-----------------------	--	-----------------------

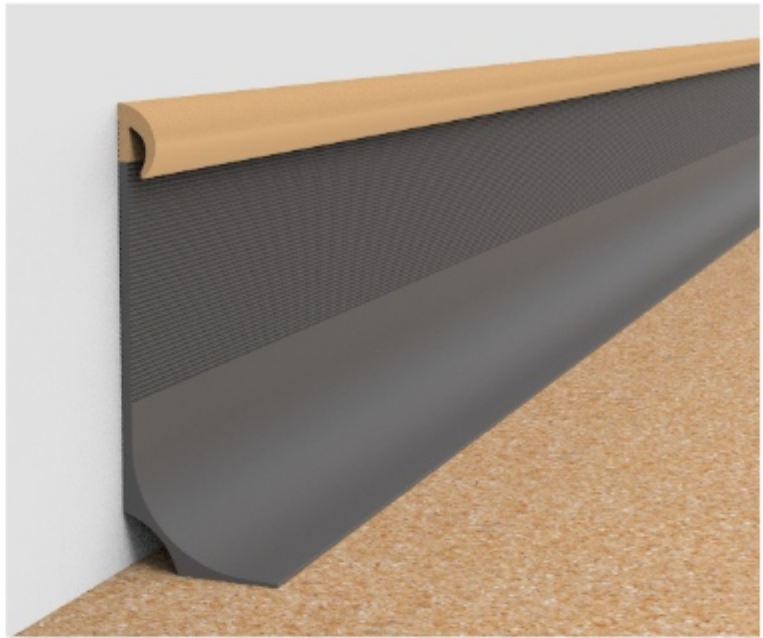
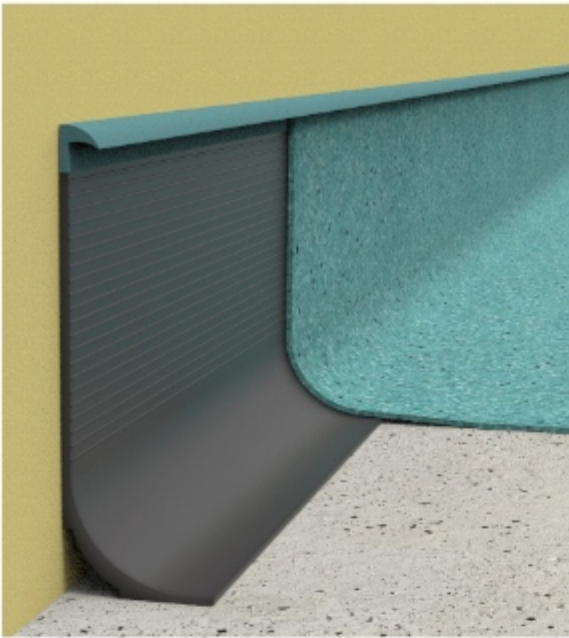

FLEXIBLE PVC SKIRTINGS

Suitable with PVC floor coverings, decorative pvc elastic skirting. PS5510 - PS7510 and PS9010 models are compatible to epoxy floorings

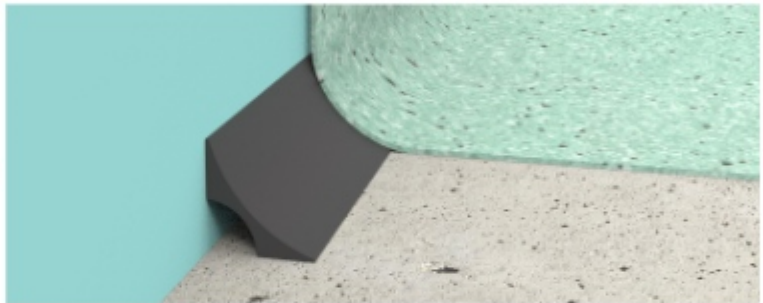

PS 85

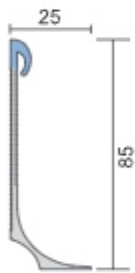

PS 86

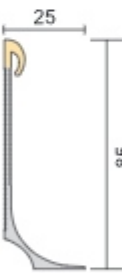

PS 10010

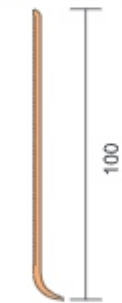

PS 5510

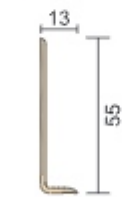

PS 7510



PS 9010



PS 100



PS 3030

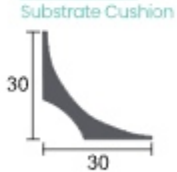

PS 2020

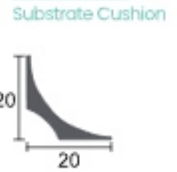

PS0004



PS28

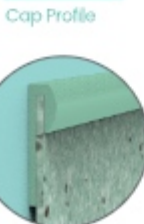

ALUMINIUM
& PVC
SKIRTINGS

SB 10 STAIR NOSING PROFILE

Lightweight, easy applicable and fully compatible of ceramic, granit applications decorative stair nosing profiles
Method of Application: Adhesive bonded or screw mounted
Length : 2,70 mt Color: Mat Anodised, Yellow Anodised

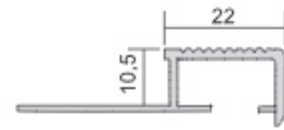

SB 10-12 STAIR NOSING PROFILE

Lightweight, easy applicable and fully compatible of ceramic, granit applications decorative stair nosing profiles
Method of Application: Adhesive bonded or screw mounted
Length : 2,70 mt Color: Mat Anodised, Yellow Anodised

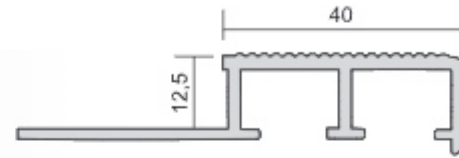

SB 11 RUBBER INSERTED STAIR NOSING PROFILE

Lightweight, easy applicable, rubber inserted and fully compatible of ceramic, granit applications decorative stair nosing profiles
Method of Application: Adhesive bonded or screw mounted
Length : 2,70 mt Rubber Insert Colors: Black, grey, cream and brown

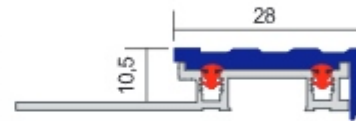

SB 11-12 RUBBER INSERTED STAIR NOSING PROFILE

Lightweight, easy applicable, rubber inserted and fully compatible of ceramic, granit applications decorative stair nosing profiles
Method of Application: Adhesive bonded or screw mounted
Length : 2,70 mt Rubber Insert Colors: Black, grey, cream and brown

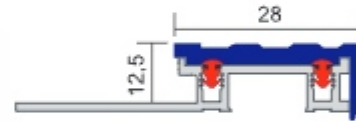

MB 36 RUBBER INSERTED STAIR NOSING PROFILE

Lightweight, easy applicable, rubber inserted and fully compatible of ceramic, granit applications decorative stair nosing profiles
Method of Application: Adhesive bonded or screw mounted
Length : 2,70 mt Color: Mat Anodised, Yellow Anodised

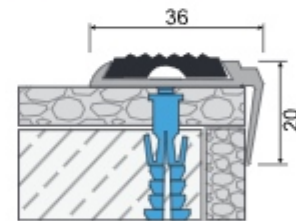

MB 41 RUBBER INSERTED STAIR NOSING PROFILE

Lightweight, easy applicable, rubber inserted and fully compatible of ceramic, granit applications decorative stair nosing profiles
Method of Application: Adhesive bonded or screw mounted
Length : 2,70 mt Color: Mat Anodised, Yellow Anodised

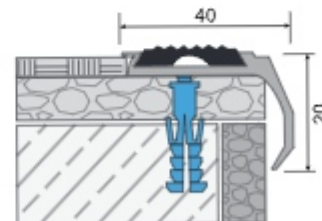

MB 50 RUBBER INSERTED STAIR NOSING PROFILE

Lightweight, easy applicable, rubber inserted and fully compatible of carpet applications decorative stair nosing profiles
Method of Application: Adhesive bonded or screw mounted
Length : 2,70 mt Color: Mat Anodised, Yellow Anodised

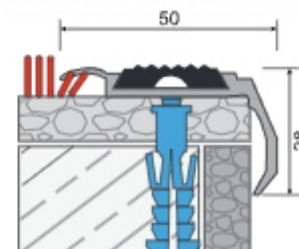

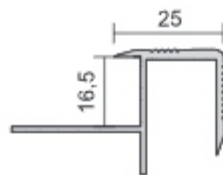

HB 25 STAIR NOSING PROFILE

Lightweight, easy applicable, rubber inserted and fully compatible of parquet applications decorative stair nosing profiles
 Method of Application: Adhesive bonded or screw mounted
Length : 2,70 mt **Color**: Mat Anodised, Yellow Anodised

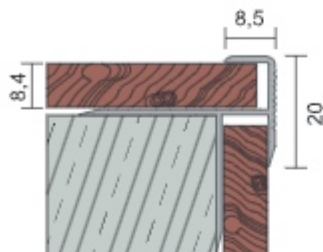

HB 18 STAIR NOSING PROFILE

Lightweight, easy applicable, rubber inserted and fully compatible of parquet applications decorative stair nosing profiles
 Method of Application: Adhesive bonded or screw mounted
Length : 2,70 mt **Color**: Mat Anodised, Yellow Anodised

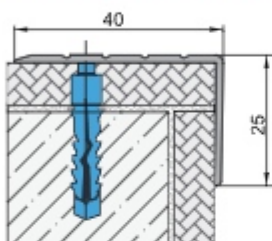

MB 40-25 STAIR NOSING PROFILE

Lightweight, easy applicable and fully compatible of ceramic, granit applications decorative stair nosing profiles
 Method of Application: Adhesive bonded or screw mounted
Length : 2,70 mt **Color**: Mat Anodised, Yellow Anodised

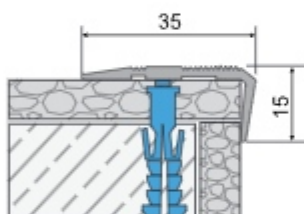

MB 35 STAIR NOSING PROFILE

Lightweight, easy applicable and fully compatible of ceramic, granit applications decorative stair nosing profiles
 Method of Application: Adhesive bonded or screw mounted
Length : 2,70 mt **Color**: Mat Anodised, Yellow Anodised

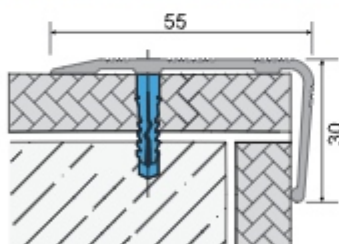

MB 55-1 STAIR NOSING PROFILE

Lightweight, easy applicable and fully compatible of ceramic, granit applications decorative stair nosing profiles
 Method of Application: Adhesive bonded or screw mounted
Length : 2,70 mt **Color**: Mat Anodised, Yellow Anodised

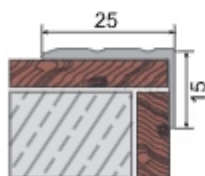

MB 25 STAIR NOSING PROFILE

Lightweight, easy applicable and fully compatible of ceramic, granit applications decorative stair nosing profiles
 Method of Application: Adhesive bonded or screw mounted
Length : 2,70 mt **Color**: Mat Anodised, Yellow Anodised

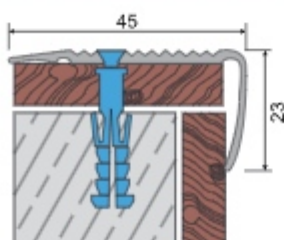

MB 45 STAIR NOSING PROFILE

Lightweight, easy applicable and fully compatible of ceramic, granit applications decorative stair nosing profiles
 Method of Application: Adhesive bonded or screw mounted
Length : 2,70 mt **Color**: Mat Anodised, Yellow Anodised

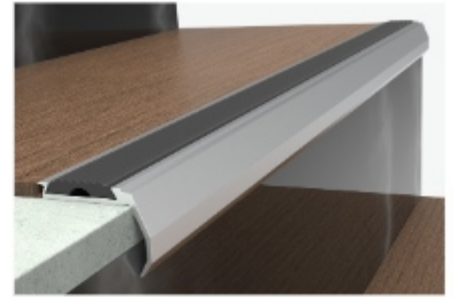
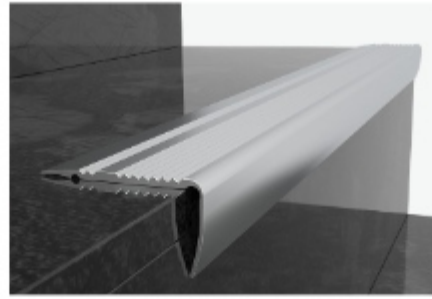
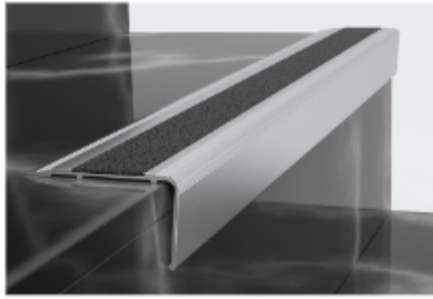

MB 55P STAIR NOSING PROFILE

Lightweight, easy applicable and fully compatible of PVC flooring applications decorative PVC stair nosing profiles
 Method of Application: Adhesive bonded
 Length : 2,70 mt Color: Various Colors

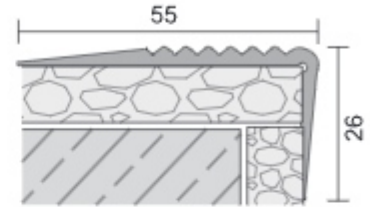

MB 76 STAIR NOSING PROFILE

Lightweight, easy applicable and fully compatible of PVC flooring applications decorative PVC stair nosing profiles
 Method of Application: Adhesive bonded
 Length : 2,70 mt Color: Various Colors

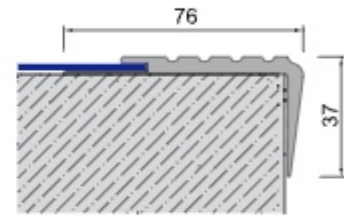

MB 40 STAIR NOSING PROFILES WITH ANTI SLIP TAPE

Lightweight, easy applicable and fully compatible of ceramic, granit applications decorative stair nosing profiles with anti slip tape
 Method of Application: Adhesive bonded or screw mounted
 Length : 2,70 mt Color: Mat Anodised, Yellow Anodised

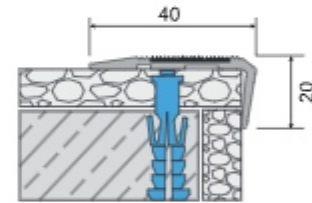

Bant Renkleri

MB 55 STAIR NOSING PROFILES WITH ANTI SLIP TAPE

Lightweight, easy applicable and fully compatible of ceramic, granit applications decorative stair nosing profiles with anti slip tape
 Method of Application: Adhesive bonded or screw mounted
 Length : 2,70 mt Color: Mat Anodised, Yellow Anodised

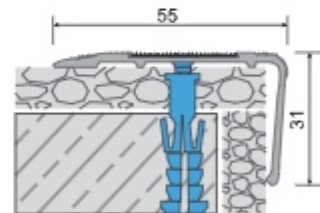

Bant Renkleri

MB 75-2 STAIR NOSING PROFILES WITH ANTI SLIP TAPE

Lightweight, easy applicable and fully compatible of ceramic, granit applications decorative stair nosing profiles with anti slip tape
 Method of Application: Adhesive bonded or screw mounted
 Length : 2,70 mt Color: Mat Anodised, Yellow Anodised

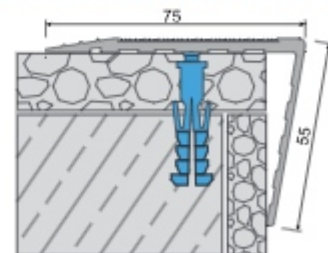

Bant Renkleri

KB 19 - KB 25 ANTI SLIP TAPE

Self adhesive carborandum anti slip tape in 19 mm and 25 mm width
 Method of Application: Adhesive bonded
 Length : 25 mt Color: Black and grey



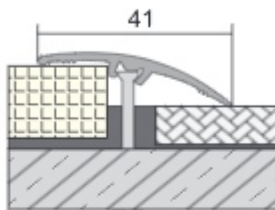
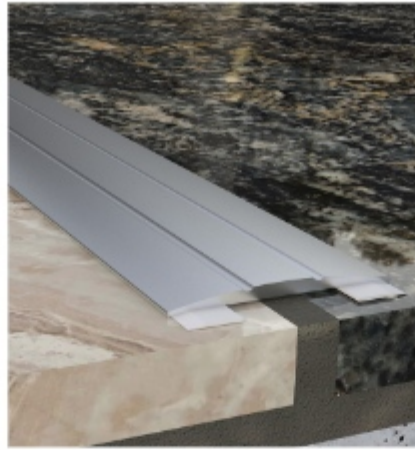

GP 41 ELEVATION DIFFERENCE PROFILE WITH HIDDEN SCREW MOUNTED CHANNEL

Lightweight, easy applicable and fully compatible of ceramic, granit, marble, parquet applications, decorative elevation difference profiles
 Method of Application: Adhesive bonded or screw mounted
Length : 2,70 mt **Color**: Mat Anodised, Yellow Anodised

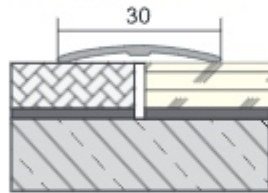

GP 01 ELEVATION DIFFERENCE PROFILE

Lightweight, easy applicable and fully compatible of ceramic, granit, marble, parquet applications, decorative elevation difference profiles
 Method of Application: Adhesive bonded
Length : 2,70 mt **Color**: Mat Anodised, Yellow Anodised

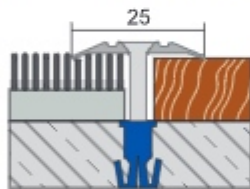

GP 25 ELEVATION DIFFERENCE PROFILE

Lightweight, easy applicable and fully compatible of ceramic, granit, marble, parquet applications, decorative elevation difference profiles
 Method of Application: Adhesive bonded or screw mounted
Length : 2,70 mt **Color**: Mat Anodised, Yellow Anodised

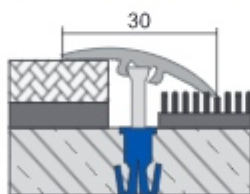

GP 30 ELEVATION DIFFERENCE PROFILE WITH HIDDEN SCREW MOUNTED CHANNEL

Lightweight, easy applicable and fully compatible of ceramic, granit, marble, parquet applications, decorative elevation difference profiles
 Method of Application: Adhesive bonded or screw mounted
Length : 2,70 mt **Color**: Mat Anodised, Yellow Anodised

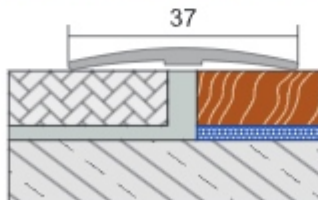

GP 37 ELEVATION DIFFERENCE PROFILE

Lightweight, easy applicable and fully compatible of ceramic, granit, marble, parquet applications, decorative elevation difference profiles
 Method of Application: Adhesive bonded
Length : 2,70 mt **Color**: Mat Anodised, Yellow Anodised

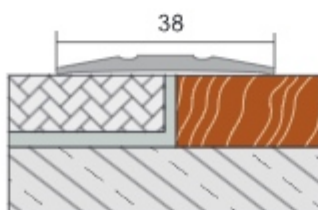

GP 38 ELEVATION DIFFERENCE PROFILE

Lightweight, easy applicable and fully compatible of ceramic, granit, marble, parquet applications, decorative elevation difference profiles
 Method of Application: Adhesive bonded or screw mounted
Length : 2,70 mt **Color**: Mat Anodised, Yellow Anodised

GP 39 ELEVATION DIFFERENCE PROFILE

Lightweight, easy applicable and fully compatible of ceramic, granite, marble, parquet applications, decorative elevation difference profiles
Method of Application: Adhesive bonded
Length : 2,70 mt Color: Mat Anodised, Yellow Anodised

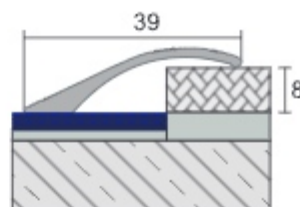

GP 50 ELEVATION DIFFERENCE PROFILE

Lightweight, easy applicable and fully compatible of ceramic, granite, marble, parquet applications, decorative elevation difference profiles
Method of Application: Adhesive bonded or screw mounted
Length : 2,70 mt Color: Mat Anodised, Yellow Anodised

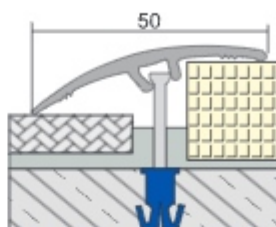

KF 28 ELEVATION DIFFERENCE PROFILE

Lightweight, easy applicable and fully compatible of ceramic, granite, marble, parquet applications, decorative elevation difference profiles
Method of Application: Adhesive bonded or screw mounted
Length : 2,70 mt Color: Mat Anodised, Yellow Anodised

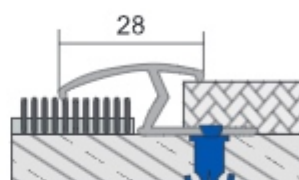

KF 35 ELEVATION DIFFERENCE PROFILE

Lightweight, easy applicable and fully compatible of ceramic, granite, marble, parquet applications, decorative elevation difference profiles
Method of Application: Adhesive bonded
Length : 2,70 mt Color: Mat Anodised, Yellow Anodised

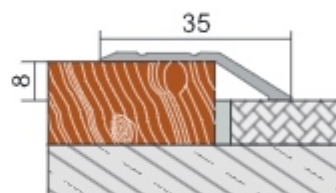

KF 45 ELEVATION DIFFERENCE PROFILE

Lightweight, easy applicable and fully compatible of ceramic, granite, marble, parquet applications, decorative elevation difference profiles
Method of Application: Adhesive bonded or screw mounted
Length : 2,70 mt Color: Mat Anodised, Yellow Anodised

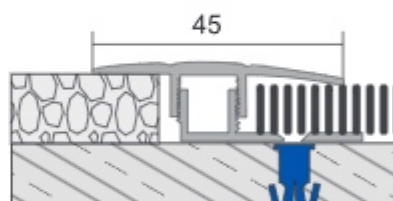

HB 12 CARPET AND PARQUET TRIM PROFILE

Lightweight, easy applicable and fully compatible of carpet, parquet applications, decorative trim profiles
Method of Application: Adhesive bonded or screw mounted
Length : 2,70 mt Color: Mat Anodised, Yellow Anodised

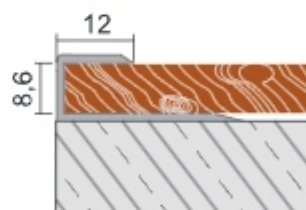

HB 14 CARPET TRIM PROFILE

Lightweight, easy applicable and fully compatible of carpet applications, decorative trim profiles
Method of Application: Adhesive bonded or screw mounted
Length : 2,70 mt Color: Mat Anodised, Yellow Anodised

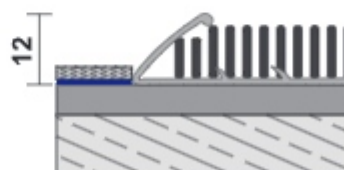

HB 19 PARQUET TRIM PROFILE

Aluminium parquet trim profiles
Method of Application: Adhesive bonded or screw mounted
Length : 2,70 mt Color: Mat Anodised, Yellow Anodised

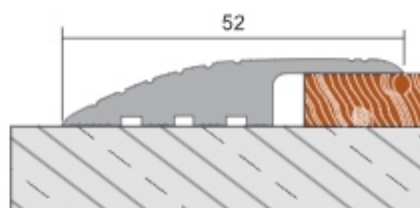

EXTERNAL CERAMIC TRIM PROFILES

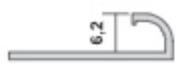

» SB 0206



» SB 0201



» SB 02

Aluminium external ceramic trim profiles

Length: 2,70 m

Color: Mat Anodised, Yellow Anodised, Polished Anodised



» SB 03



» SB 12

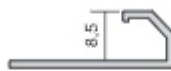

» SB 04

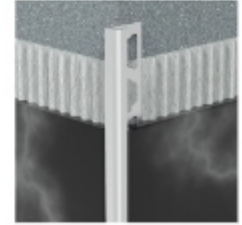
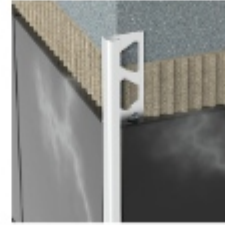

INTERNAL CERAMIC TRIM PROFILES

Aluminium Internal Ceramic Trim Profiles

Length: 2,70 m

Color: Mat Anodised, Yellow Anodised, Polished Anodised

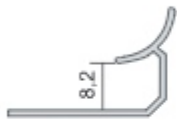

» İK 08

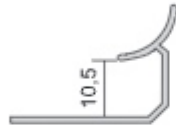

» İK 10

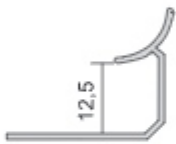

» İK 12

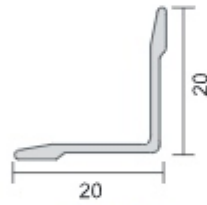

» İK 20

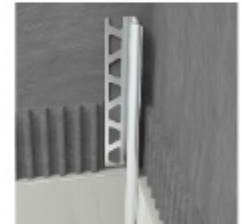
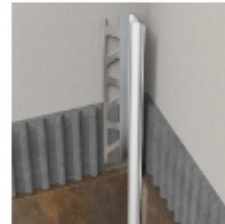

CERAMIC TRIM PROFILES

Aluminium ceramic trim profiles

Length: 2,70 m

Color: Mat Anodised, Yellow Anodised, Polished Anodised



» SB 05



» SB 06



» SB 07



» SB 08



» SB 15



» SB 07-25



» SB 09

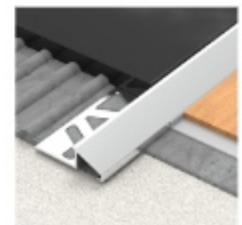

İK 27 BATHTUB EDGE PROFILE

Lightweight, easy applicable and fully compatible of bath, kitchen applications, decorative pvc bathtub edge profiles
 Method of Application : Adhesive bonded
Length : 2,50 - 2,70 - 3,00 mt **Color**: White

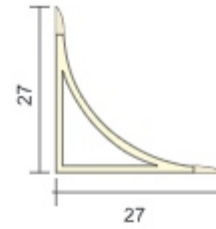

İK 30 BATHTUB EDGE PROFILE

Lightweight, easy applicable and fully compatible of bath, kitchen applications, decorative two part pvc bathtub edge profiles
 Method of Application : Adhesive bonded **Length** : 2,70 mt
Middle Part Color: White(PVC) and Mat or polished anodised (Aluminium)

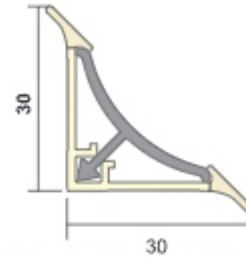

İK 22 BATHTUB EDGE PROFILE

Lightweight, easy applicable and fully compatible of bath, kitchen applications, decorative pvc bathtub edge profiles
 Method of Application : Adhesive bonded
Length : 2,70 mt **Color**: White

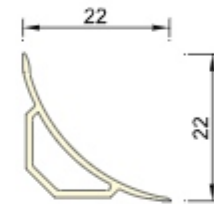

KERB PROFILES

Lightweight, easy applicable and fully compatible of ceramic, granit, marble applications, decorative kerb profiles
 Method of Application: Adhesive bonded
Length : 2,70 mt **Color**: Mat Anodised, Yellow Anodised, Polished Anodised

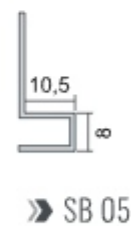
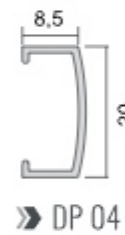
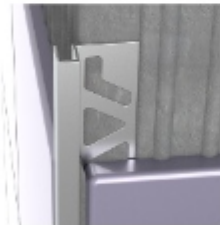

TRANSITION PROFILES

Lightweight, easy applicable and fully compatible of parquet, ceramic, granit, marble applications, decorative profiles
 Method of Application: Adhesive bonded
Length : 2,70 mt **Color**: Mat Anodised, Yellow Anodised, Polished Anodised

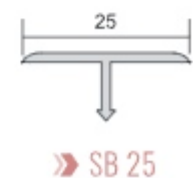
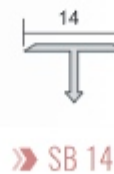
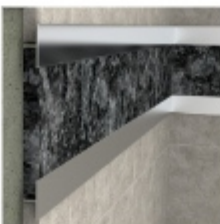

TERRAZO PROFILES

Aluminium terrazo profiles

Length: 3 m

Color : Non Anodised Aluminium

» SB 53

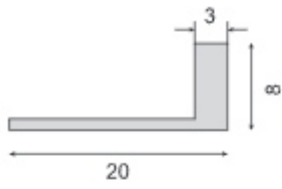

» SB 54

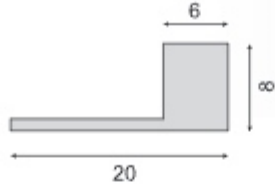

» SB 55

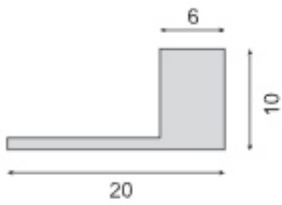

» SB 56

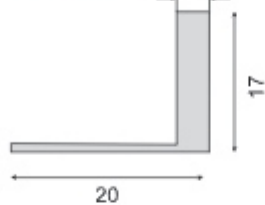

» SB 57

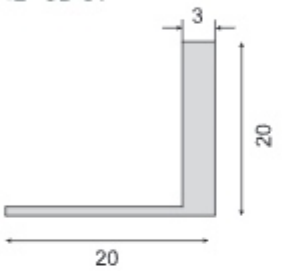

» SB 58

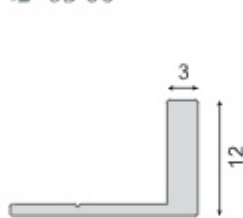

» SB 59



» SB 60

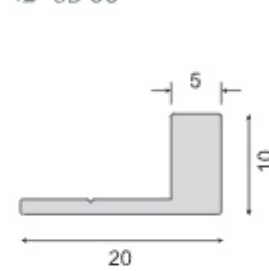

» SB 61

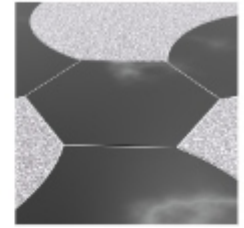
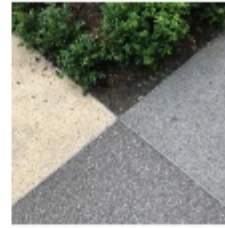
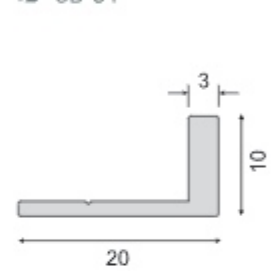

DRYWALL FUGA PROFILES

Aluminium drywall fuga corner and trim profiles

Length: 3,00 m Color: Standard production color RAL9016 and

can be produced in special RAL colors

» ARF 10

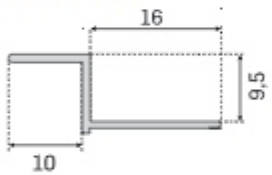

» ARF 15

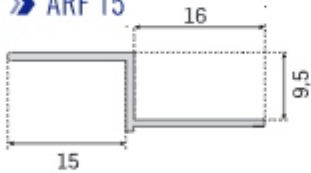

» ARF 10-1

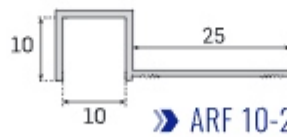

» ARF 10-2

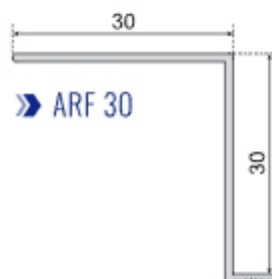

» ARF 30

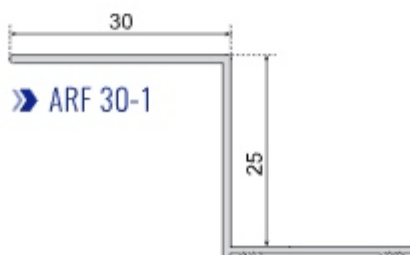

» ARF 30-1

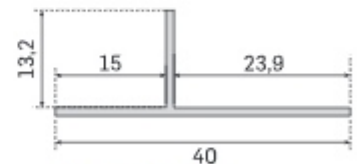
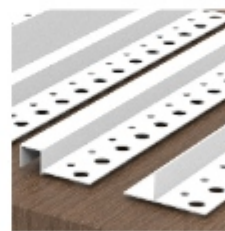

» ARF 40x15

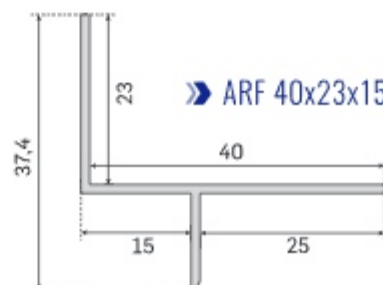

» ARF 40x23x15

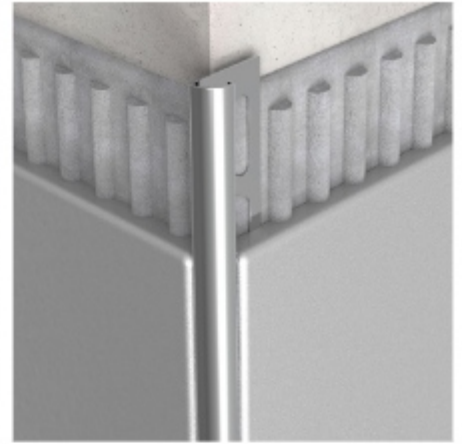
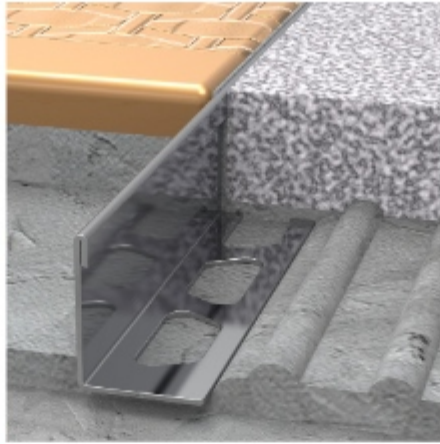
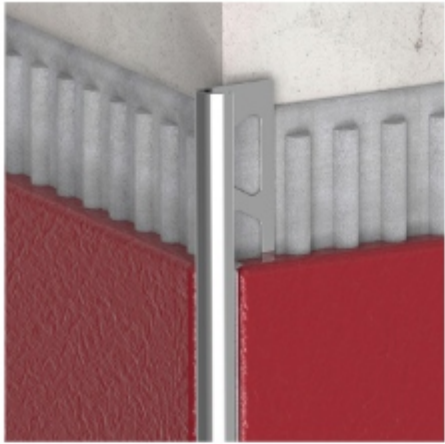

SB03-01 10 MM STAINLESS STEEL CERAMIC CORNER PROFILE

Length: 2,50 m

Color: Satine

Produced as 304 grade stainless steel and thickness is 0,6 mm



SB12-01 12 MM STAINLESS STEEL CERAMIC CORNER PROFILE

Length: 2,50 m

Color: Satine

Produced as 304 grade stainless steel and thickness is 0,6 mm



SB05-01 STAINLESS STEEL CERAMIC CORNER PROFILE

Length: 2,50 m

Color: Satine

Produced as 304 grade stainless steel and thickness is 0,6 mm

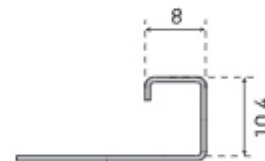

SB07-01 10 MM STAINLESS STEEL CERAMIC TRIM PROFILE

Length: 2,50 m

Color: Satine

Produced as 304 grade stainless steel and thickness is 0,6 mm



SB08-01 12 MM STAINLESS STEEL CERAMIC TRIM PROFILE

Length: 2,50 m

Color: Satine

Produced as 304 grade stainless steel and thickness is 0,6 mm



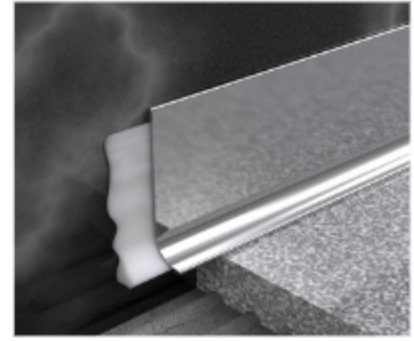
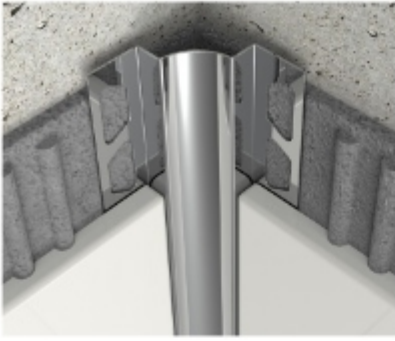

SB08-20 20 MM STAINLESS STEEL CERAMIC TRIM PROFILE



Length: 2,50 m

Color: Satine

Produced as 304 grade stainless steel and thickness is 0,6 mm

DP05-01 23 MM STAINLESS STEEL FUGA PROFILE



Length: 2,50 m

Color: Satine

Produced as 304 grade stainless steel and thickness is 0,6 mm

ASP60-01 STAINLESS STEEL SKIRTING



Method of Application: Adhesive bonded

Length : 2,50 mt **Color:** Satine

Produced as 304 grade stainless steel and thickness is 0,6 mm

IK10-02 STAINLESS STEEL INTERNAL CORNER PROFILE

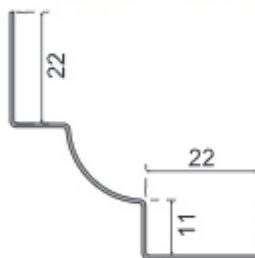

Length : 2,50 mt

Color: Satine

Produced as 304 grade stainless steel and thickness is 0,6 mm

CG (30S, 50S, 75S, 100S) STAINLESS STEEL CORNER PROTECTION

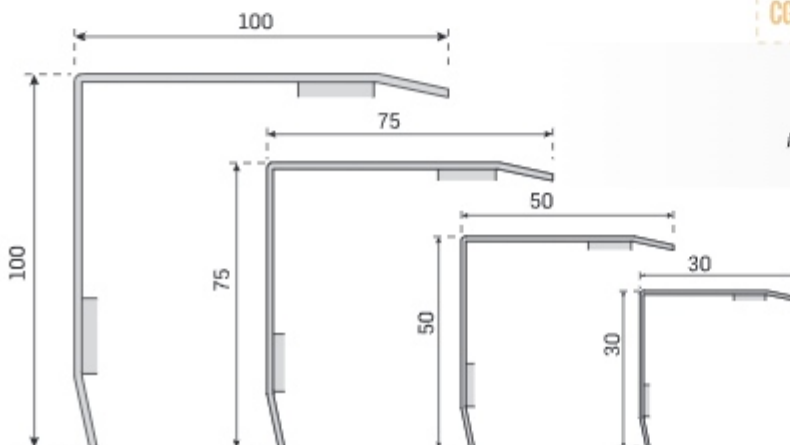

Length : 3,00 mt

Color: Satine

Produced as 304 grade stainless steel and thickness is 1 mm

QUALITY CERTIFICATES



ZAG Fire Rope Test Certificate

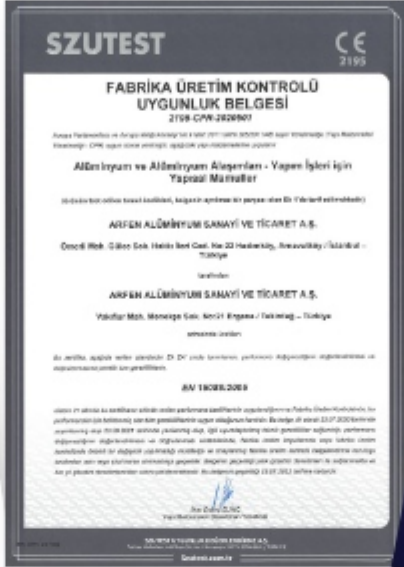

Factory Production Control Certificate of Conformity



Efectis Fire Resistance Certificate



TSE Certificate



TSE Certificate



TSE Certificate



ISO 45001 Certificate



ISO 9001:2015 Certificate



ISO 14001:2015 Certificate



QUALICOAT SEASIDE Certificate



Factory Production Control Certificate



Brand Registration Certificate



Building information
modeling is available
Please contact

we build solutions



ARFEN CONSTRUCTION AND BUILDING TECHNOLOGIES COMPANY

Head Office: Atatürk San. Bölgesi Ömerli Mah. Hakkı İleri Cad.
Gülce Sk. No:22 Hacımköy - Arnavutköy / İSTANBUL
Tel: +90 212 485 16 15 - **Fax:** +90 212 771 25 79 - www.arfen.com

ARFEN ALUMINIUM COMPANY

Ergene / TEKİRDAĞ - www.arfenaluminium.com.tr

ARFEN BUILDING AND BRIDGE TECHNOLOGY

Dilovası / Kocaeli - www.arfen.com.tr

TURKEY